



Review Article

Coal mine methane: A review of capture and utilization practices with benefits to mining safety and to greenhouse gas reduction

C. Özgen Karacan^{a,*}, Felicia A. Ruiz^b, Michael Coté^c, Sally Phipps^c

^a NIOSH, Office of Mine Safety and Health Research, Pittsburgh, PA, USA

^b US EPA, Coalbed Methane Outreach Program, Washington, DC, USA

^c Ruby Canyon Engineering, Grand Junction, CO, USA

ARTICLE INFO

Article history:

Received 30 December 2010

Received in revised form 16 February 2011

Accepted 18 February 2011

Available online 22 March 2011

Keywords:

Coal mine methane

Mining safety

Methane drainage

Ventilation air methane

Methane utilization

Greenhouse gas reduction

ABSTRACT

Coal mine methane (CMM) is a term given to the methane gas produced or emitted in association with coal mining activities either from the coal seam itself or from other gassy formations underground. The amount of CMM generated at a specific operation depends on the productivity of the coal mine, the gassiness of the coal seam and any underlying and overlying formations, operational variables, and geological conditions. CMM can be captured by engineered boreholes that augment the mine's ventilation system or it can be emitted into the mine environment and exhausted from the mine shafts along with ventilation air. The large amounts of methane released during mining present concerns about adequate mine ventilation to ensure worker safety, but they also can create opportunities to generate energy if this gas is captured and utilized properly. This article reviews the technical aspects of CMM capture in and from coal mines, the main factors affecting CMM accumulations in underground coal mines, methods for capturing methane using boreholes, specific borehole designs for effective methane capture, aspects of removing methane from abandoned mines and from sealed/active gobbs of operating mines, benefits of capturing and controlling CMM for mine safety, and benefits for energy production and greenhouse gas (GHG) reduction.

Published by Elsevier B.V.

Contents

1.	Introduction	122
2.	Factors affecting specific emissions in underground coal mines and estimation methods	123
2.1.	Analyses of contributors for CMM emissions for longwall mines	123
2.2.	Empirical CMM emissions prediction methods	124
2.3.	Modular CMM emission prediction methods	125
3.	Degasification of coal seam and capture of coal mine methane	126
3.1.	Degasification of coal beds using horizontal boreholes for reducing emissions	127
3.2.	Capturing methane from longwall gobbs using vertical (gob gas venthole) and cross-measure boreholes for reducing emissions	128
3.2.1.	Longwall gob gas ventholes	129
3.2.2.	Cross-measure boreholes	132
3.3.	Degasification borehole stimulation, stability, and completion issues	133
4.	Geological features and heterogeneities that affect gas emissions and removal from mines	135
4.1.	Effects of faults in coal bed on mining, mining gas emissions, and degasification efficiency	136
4.2.	Effects of partings in the coal seam for coal mine methane emissions and degasification	139
4.3.	Effects of permeability facies and spatial changes in coal types and coal microlithotypes on emissions into mines	140
5.	Methane emission and recovery from abandoned underground coal mines	141
5.1.	Detecting mine voids	141
5.2.	Methane emissions evaluation	142
6.	World coal mine methane (CMM) overview	144
6.1.	China	144
6.2.	United States	145
6.3.	India	145

* Corresponding author. Tel.: +1 412 3864008.

E-mail address: cok6@cdc.gov (C.Ö. Karacan).

7.	Benefits of capturing and utilizing CMM and mitigating CMM emissions	146
8.	CMM utilization technologies	147
8.1.	Pipeline injection	147
8.2.	Gas processing	148
8.2.1.	Nitrogen rejection unit (NRU) technologies	148
8.2.2.	Other impurity and water vapor removal technologies	148
8.2.3.	Other CMM upgrading options	149
8.3.	Power generation	149
8.3.1.	Ventilation air methane (VAM) use technologies	149
8.3.2.	Onsite use options of CMM by coal mines	150
8.4.	Emerging technologies	151
8.4.1.	Concentrators	151
8.4.2.	Lean fuel gas turbines	151
8.4.3.	Carbureted gas turbine (CGT)	151
8.4.4.	Lean-fueled turbine with catalytic combustor (CCGT)	151
8.4.5.	Lean-fueled catalytic microturbine	151
8.4.6.	Hybrid coal and VAM-fueled gas turbine	151
8.5.	Benefits and disadvantages of end-use technologies	151
9.	CMM project barriers and a global overview of projects	152
9.1.	Barriers to the recovery and use of CMM	152
9.2.	CMM capture and utilization projects	152
10.	Summary and conclusions	153
	Disclaimer	154
	References	154

1. Introduction

Coal mine methane (CMM) is a general term for all methane released mainly during and after mining operations. Although, methane captured prior to mining can also be considered associated to mining and thus can be considered as coal mine methane, it can also be termed as coalbed methane (CBM). CMM shows great variability in flow rate and composition. At a typical gassy coal mine, ventilation air may contain 0.1–1% methane, whereas gas drained from the seam before mining can contain 60% to more than 95% methane depending on the presence of other gasses in the coal seam. Gas drained from fractured formations above mined seams (gobs), on the other hand, may contain 30–95% methane depending on the locations of the boreholes and other operation and completion parameters (Karacan, 2009a). Although ventilation air methane (VAM) from shafts of active mines contributes approximately 64% of worldwide methane emissions from underground coal mines, methane concentrations in the ventilation air are different for each mine (S. Su et al., 2005; Su et al., 2008; X. Su et al., 2005). These varying concentrations impact the choice of potential capture and utilization technologies for VAM.

There are three primary incentives for recovering CMM (Bibler et al., 1998). The first and foremost reason is to improve the safety of the mines. In recent years, there have been many fatalities in underground coal mine explosions in which methane was a contributing factor. Table 1 shows some of the major mine explosions (United Nations, 2010) after 2000. Removing methane from mines can reduce the methane in working areas, thereby improving safety. The second benefit of recovering CMM is to improve mine economics by allowing

Table 1
Some of the major coal mine explosions that occurred after 2000 (modified from United Nations, 2010).

Country	Date	Coal mine	Fatalities
China	14 Feb., 2005	Sunjlawan, Haizhou shaft, Fuxin	214
USA	2 Jan., 2006	Sago, West Virginia	12
Kazakhstan	20 Sept., 2006	Lenina, Karaganda	43
Russia	19 March, 2007	Ulyanovskaya, Kemerovo	108
Ukraine	19 Nov., 2007	Zasyadko, Donetzk	80
USA	5 April, 2010	Upper Big Branch, West Virginia	29
Turkey	17 May, 2010	Karadon, Zonguldak	30

the mines to produce coal with minimum downtimes due to high methane levels. The third incentive is to reduce greenhouse gas emissions involving methane, which is about 21 times more potent than CO₂ (Warmuzinski, 2008).

Coal mine methane has always been considered as a danger for underground coal mining as it can create a serious threat to mining safety and productivity due to its explosion risk. One of the most important duties of ventilation in underground coal mines is to keep methane levels well below the explosive limit by diluting methane emissions that occur during mining. Methane entering a mine can create a localized zone of high concentration in an area of low air velocities and quantities. The concentration of methane in these zones may pass through a range between 5% and 15%, known as the explosive range. In this range, methane can be ignited easily with the presence of an ignition source to create a violent methane explosion that may propagate in the presence of combustible coal dust. Fig. 1 shows the explosibility diagram for methane (Coward and Jones, 1952).

In addition to proper ventilation practices, removal of coal mine methane from the mining environment prior to, during, and after coal

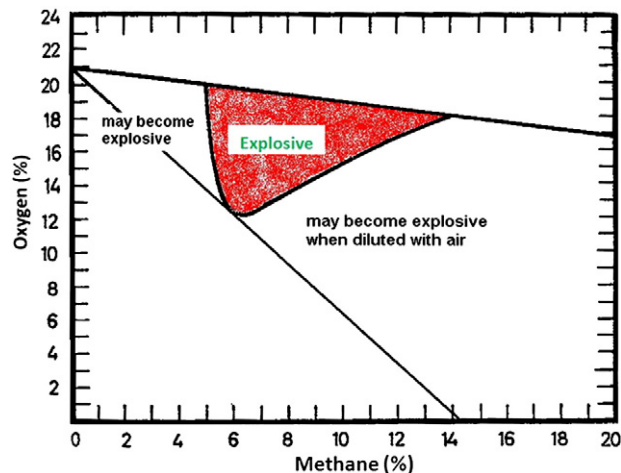

Fig. 1. Methane explosibility diagram.
Modified from Coward and Jones (1952).

production by using various in-seam and surface-to-mine borehole designs, has been the key component to alleviate the explosion threat in mining operations. However, application of these techniques requires knowledge of those operational factors that control gas emissions during mining and the geological factors that may lead to excessive emissions that can affect the performance of degasification techniques. Also important is knowledge on the accumulation of methane in sealed and active gobbs, and the size of the gas emission zone that may put abandoned workings in physical connection with the active mine.

In addition to safety concerns, methane that is emitted from domestic and international coal mines represents approximately 8% of the world's anthropogenic methane emissions contributing 17% to the total anthropogenic greenhouse gas emissions (U.S. EPA, 2003, 2010a). By 2020, CMM emissions are projected to increase, with estimates as high as 793 MtCO₂e (×1000 tons CO₂ equivalent). Underground coal mining is the most important source of fugitive methane emissions, and nearly 70% of this methane is emitted through mine ventilation air at low concentrations. Thus, CMM is an important issue from an environmental point of view. Further, capturing and utilizing this gas will not only decrease greenhouse gas emissions, but will provide an additional energy source that otherwise will be lost.

Capturing high concentrations of methane using boreholes, upgrading it to pipeline quality gas if needed, and utilizing this gas are fairly well-developed techniques. Since methane emissions from VAM represent most of the methane emissions from coal mines, much attention has been given to explore ways to capture and utilize low concentrations of methane under variable flow conditions. In addition, the quality of ventilation air and methane concentration varies in relation to dust loading, particle size distribution, and the presence of other gasses that may make a particular VAM capture and utilization technology unfeasible for a given mine. Therefore, the characteristics of ventilation air from a particular mine wanting to utilize these techniques should be well-understood (Su et al., 2008).

This article reviews the technical and geological aspects of CMM capture from active and sealed coal mines, the main factors affecting CMM accumulations in mines, and the benefits of capturing and controlling CMM for mine safety, energy production, and greenhouse gas (GHG) reduction.

2. Factors affecting specific emissions in underground coal mines and estimation methods

There are various geological and operational factors affecting a mine's methane emissions while coal is being extracted. The individual contributions of each of these factors to the total amount of emissions vary and, in most cases, may be difficult to distinguish from each other. Therefore, a relative term called "specific emissions" is used, quantified as a lumped parameter to designate the gassiness of a mine.

Specific emissions is the amount of methane generated per unit amount of coal that is mined (United Nations, 2010), and this quantity is generally used to determine the degasification and ventilation needs of a particular mine. One should be aware that this is not the gas content of the mined coal, but rather the gas amount generated as a consequence of coal extraction.

Fig. 2 shows the relationship between mine emissions and gas content of mined coal for Australian mines (Saghafi et al., 1997). As shown, the amount of mine emissions exceeded gas content of coal by a factor of 4. Kissell et al. (1973) observed similar trends for the U.S. coal mines and suggested that the mine emissions greatly exceeded (approximately 7 times) the amount expected from an analysis of coal gas content alone. The difference may be related to the differences in Australian and U.S. mining conditions and the differences in geology. However, methane that leads to specific emissions of a mine may be

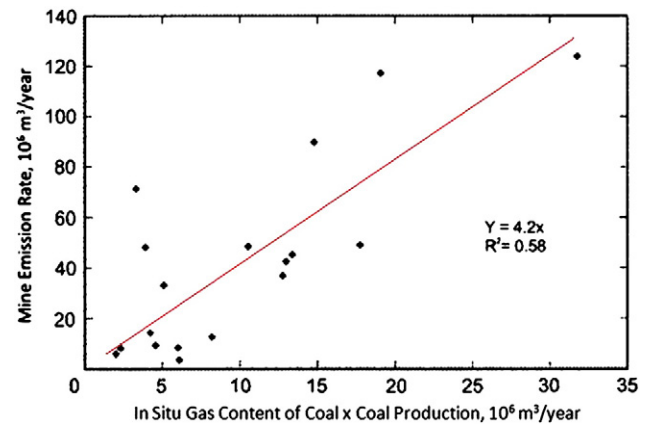

Fig. 2. Mine emissions versus gas content of mined coal. Modified from Saghafi et al. (1997).

generated from the mined coal itself and also may originate from overlying and underlying strata. In addition, the quantity may change based on the changes in operational parameters. Therefore, mine emissions are difficult to predict and may depend on many factors besides gassiness of the mined coal.

2.1. Analyses of contributors for CMM emissions for longwall mines

Karacan (2008a,b) compiled data on mine operational parameters, seam depths, locations, coal gas contents, and methane emissions from U.S. longwall operations that spanned a period of 20 years. The data were analyzed using multiple regression and neural networks. In order to reduce model complexity, principal component analysis (PCA) was performed to determine the weight of each parameter on methane emissions. Below is a brief discussion on the influence of individual parameters on methane emissions in coal mines and the results of PCA to determine the most influential parameters.

Gas content is one of the key data included in coalbed methane resource estimations (Boyer and Qingzhao, 1998). The gas content data, when combined with geologic and engineering data, can be used as a basis for an initial estimate of methane emissions and ventilation requirements (Diamond et al., 1986; Karacan and Diamond, 2006; Noack, 1998). During mining, all three components of coal gas content (lost, desorbed, and residual) can potentially contribute to methane emissions into the mine atmosphere.

Rank represents the level of maturation reached in a coal seam and usually increases with increasing depth. Most longwalls, as well as most commercial coalbed methane projects, operate in bituminous coal beds. The coals of sub-bituminous to low-volatile bituminous range usually provide high gas content and natural permeability (Steidl, 1996). Mining coals of this rank, particularly medium- to low-volatile bituminous coals, potentially liberates high amounts of gas into the ventilation system.

Depth of the mined coal seam, or its overburden impacts methane emissions in two ways. First, for coals of the same rank, gas content generally increases with increasing depth (Kim, 1977). Second, overburden impacts the disturbance created in the overlying strata. This effect is related to the width of the extracted panel. If panel width is greater than overburden depth, the panel is referred to as a "supercritical" panel, where the caving will be more complete after mining compared to a situation where the panel width is less than the overburden depth. Complete caving in the case of a supercritical panel creates a larger volume of fractured strata in overlying formations.

Panel dimensions influence methane emissions by impacting the dimensions of the subsided strata overlying the extracted panel and the emissions from the longwall face. The increasing size of longwall panels, while helping to increase coal production, may also increase

methane emissions due to the exposure of the mining environment to a larger area of fractured, gas-bearing strata.

Cut depth is the slice of coalbed that is mined by the shearer during each pass. In general, the greater the cutting depth, the more coal is produced per rotation of the cutting drums and the greater the emissions. However, emissions may also be affected by the rotational speed of the cutting drums and the loading rate of the shearer. If the drums are rotating fast compared to haulage speed, then a finer coal fraction is produced (Peng, 2006), which potentially increases emissions.

Face conveyor and stage loader speed should be at high capacity and should be as fast as is practical to ensure continued coal production. These speeds are important so that the coal is moved from the face area as quickly as possible to minimize emissions from the broken coal on the conveyor.

Coal production is affected by most of the operational parameters contributing to gas emissions, too. Practical experience has shown that gas emissions are directly related to coal production, and the more coal that is mined, the higher the emissions rates. This is one of the reasons why coal production is used as one of the major parameters, or the sole one, in most empirical models studying methane gas emissions.

Mining height is usually equal to or related to the seam height. In some thin-seam mines, the roof is also extracted to make room for equipment and personnel. Seam and mining height impact coal mine emissions because thick, permeable, and gassy coal beds potentially generate more gas from the longwall face compared to their thinner counterparts. In addition, caving height is proportional to mining height (Peng, 2006). Thus, the greater the mining height, the higher the caving will be and the greater the potential for more gas to flow into the gob from the overlying strata and into the mine.

The number of gate roads used varies based on the needs of the operation. In the U.S., some of the early longwalls used five-entry gateroads. Today, three-entries are preferred since they require less development footage compared to four- or five-entry systems. A four-entry system is used in coal seams of low height or high gas content where additional gateroads are needed to minimize airflow resistances or to improve methane dilution by increasing ventilation quantities. Two-entry gateroads require a special variance and are used in deep mines with a thick layer of strong overlying strata, such as operations in Colorado and Utah (Peng, 2006).

Degasification can be used for controlling methane emissions prior to and during mining. An effective degasification process can reduce emissions into the ventilation system (Diamond, 1994; Thakur and Poundstone, 1980). Depending on the gassiness of the coal seam and the fractured strata, horizontal boreholes, vertical boreholes, or gob gas ventholes can be used. The number of boreholes, their locations, and their degasification durations may change based on site-specific factors (Diamond, 1994).

A strong relationship exists between gas emissions rates and geological factors, such as stratigraphy, and the gas contents and strengths of the overlying and underlying strata. There is not a simple solid mathematical expression to uncover this relation. Geomechanical models coupled with fluid-flow models are usually used to investigate this relationship. However, it is known that when the overlying formations are thin and weak, and when are they gassy and in close proximity to the mined seams the emissions increase. Also, coal beds are strongly affected by regional sedimentology and tectonics. Pashin (1998) reported, based on investigations in the Black Warrior Basin and in the San Juan Basin, that regional variations in sequence stratigraphy were useful for characterization of coalbed methane reservoirs. Although geographical location is not directly related to methane emissions, it can be used indirectly to identify the differences in underground stratigraphy between different locations.

The discussions in this section show that complex relations exist between different factors and the resultant emissions rates from longwall operations. In fact, these relations are too complex to be explained by simple equations. Table 2 gives the PCA factor loadings

Table 2

Factor loadings of the variables after rotating the principal component (PC_R) matrix using Kaiser's varimax rotation. Boldfaced entries show the most influential variables in each PC_R.

Variables	PC _R 1	PC _R 2	PC _R 3	PC _R 4	PC _R 5
Presence or absence of degasification	0.472	0.221	0.163	0.245	0.538
Basin	−0.287	−0.007	0.917	−0.136	−0.145
State	0.002	0.049	0.951	−0.196	0.002
Seam height	0.064	0.113	−0.093	0.925	−0.063
Cut height	0.048	−0.027	−0.225	0.911	−0.043
Panel width	0.036	0.798	−0.006	0.004	−0.029
Panel length	−0.248	0.701	0.093	−0.202	0.052
Overburden thickness	0.808	−0.075	−0.129	0.108	0.121
Number of entries	0.271	−0.178	−0.045	−0.224	0.805
Cut depth	0.125	0.745	0.056	0.142	−0.076
Face conveyor speed	0.145	0.834	0.116	0.056	−0.167
Stage loader speed	0.147	0.811	−0.048	0.070	0.105
Lost + desorbed gas contents	0.954	0.024	−0.187	0.065	−0.011
Residual gas content	−0.244	0.237	0.748	0.032	0.372
Total gas content	0.960	0.077	−0.036	0.076	0.068
Rank	0.907	0.031	−0.174	−0.091	0.186
Coal production	−0.221	0.688	0.251	0.114	0.036

and the most influential variables for mine methane emissions. In this table, the higher numbers (factor loadings) associated with different variables show the importance of that variable in each of the principal components. In addition, positive numbers indicate a positive effect on principal components, whereas negative numbers indicate negative correlation. Principal component analysis helps select the most influential parameters for model development and thus is an effective technique for simplifying the predictive models.

2.2. Empirical CMM emissions prediction methods

Accurate estimation of the rate of methane emissions from mines, i.e., specific emissions, can be challenging due to the large number of variables involved with mining operation. On the premise that gas emissions in underground mine environments can be linked to different stages in the life of a coal mine, the following empirical model was suggested (Lunarzewski, 1998):

$$Q(y) = \frac{g}{CA} \left(\sum_0^{y+1} C \right)^m + 1 - \sum_0^y C^m + 1 \quad (1)$$

where $Q(y)$ is the average methane emissions in a year y of the mine's existence (m^3), CA is the coal production in the most recent year only (tons), C is the coal production for the life of the mine up to year y (tons), and g and m are the site-specific coefficients dependent upon geological and mining conditions. In other words, this approach summarizes methane emissions as a function of coal production only and lumps other variables into empirical constants.

In a separate study, Kirchgessner et al. (1993) presented an equation based on the multi-linear regression technique between coalbed methane contents, coal productions, and mine emissions (with $R^2 = 0.59$). The relationship that the authors generated is presented in Eq. (2). The form of the equation that they developed is a standard multi-linear function with a slope and intercept. The reason there is a non-zero intercept in this functional relationship is that methane emissions can occur at underground coal mines even at very low or at zero production rates.

$$Q(y) = 1.08 \times 10^7 (CP \times GC) + 31.44 - 26.76(DV) \quad (2)$$

In this equation, $Q(y)$ is the average methane emissions in a year, CP is the annual coal production (tons), GC is the gas content of the

coal (m^3/ton), and DV is a dummy variable that takes the value “1” if $(\text{CP} \times \text{GC})$ is less than 7.6×10^5 , and “0” if $(\text{CP} \times \text{GC})$ is greater than or equal to 7.6×10^5 .

Creedy (1993) used historical methane emissions to atmosphere from deep mines in Britain. He summed the contributions from the non-draining mines, the mines with methane drainage, and the coal in transit or storage on the surface, obtaining the following relationship:

$$E_D = LP_w + (1.857D) + F + RP_t - \quad (3)$$

where E_D is the emission, P_w is the annual coal production from mines without methane drainage, P_t is the total annual deep mine coal production, D is the total annual methane drained from all mines, F is the difference between drained and utilized methane, L is the specific emission for mines without drainage (assumed to be $6 \text{ m}^3/\text{ton}$), and R is the residual gas content of coal arriving at the surface (assumed to be $2 \text{ m}^3/\text{ton}$).

A lumped-parameter approach for estimating the instantaneous volume of gas released from all potential sources is given by Lunarzewski (1998):

$$R = a\sqrt{\text{CP}} + b \quad (4)$$

In this equation, R is the total methane emissions rate (l/s), CP is the daily coal production rate (tons), and a and b are empirical constants related to coal production levels and number of working days per week.

Lunarzewski (1998) has also described gas emission into underground workings as a combination of the quantity of gas released from both the mined coal seam and adjacent strata. This empirical relationship is expressed as:

$$Q(y) = Q_m + \sum \frac{\text{GC}_f \times \text{DC}_f \times \text{TA}_f}{\text{TM}} + \sum \frac{\text{GC}_r \times \text{DC}_r \times \text{TA}_r}{\text{TM}} \quad (5)$$

where $Q(y)$ is the quantity of gas emission into the mine per ton of mined coal, Q_m is the gas quantity released from the mined coal seam, GC is the gas content in the floor (f), and roof (r), DC is the degassing coefficient for (f) and (r), TA is the thickness of the gassy strata in (f) and (r), and TM is the thickness of the mined coal seam. The difference between this method and the previous ones is that this relation includes gas emissions from the floor and roof as well. However, the inherent difficulty is that the parameters required to include these emissions are not always easy to define correctly.

One of the methods that can be considered empirical in nature is based on classification and regression tree (CART) analysis of the potential contributors for mine emissions and their values. CART represents a computational-statistical algorithm which predicts in the form of a decision tree. The CART procedure can be defined as a partition method of data into terminal nodes (child nodes) by a sequence of binary splits, starting at a parent node. CART repeats the partition for each child node, continuing recursively until the homogeneous level in the generic node required is obtained or a given stopping criterion is verified. This method has been applied to predict the range of methane emissions from mines operating with and without a degasification system to attain certain productivity goals under ventilation constraints (Karacan and Goodman, submitted for publication). The models are presented in terms of rules that give the ranges of parameters to attain for potential emissions for target productivity values. Table 3 gives a set of example rules for mines using degasification for achieving coal production between 8.904 Mt/day and 28.219 Mt/day without exceeding a predicted methane emission level. For instance, the first rule in this table states that a coal production between 8.904 and 28.219 Mt/day can be achieved without exceeding 50.97 Mm^3/day methane emission rates only if the variables given for this rule are within the stated ranges.

Table 3

Example rules for achieving coal production between 8.904 Mt/day and 28.219 Mt/day without exceeding a predicted methane emissions level (CH: cut height (mm); PW: panel width (m); SLS: stage loader speed (m/min); LD-GAS: lost + desorbed gas (m^3/ton); HC: heat content (kcal/kg); OB: overburden (m); SULP: sulfur (%); ENT: number of gateroad entries; CD: cut depth (m); FCS: face conveyor speed (m/min)).

Methane emission (Mm^3/day)	Rules for daily coal production amount [8.904, 28.219] Mt/day
50.97	CH [1.47, 1.93] PW [192, 222.5] SLS [85.3, 116.4] HC [5229, 7120.4] LD-GAS [1.27, 4.12]
110.44	OB [262.9, 312.4] SLS [155.1, 167.6] ENT [3] SULP [2.185, 3] CD [0.98, 1.12] HC [7120.4, 7810] LD-GAS [1.27, 4.12]
166.59	CH [1.94, 1.98] SLS [85.3, 155.1] ENT [3] SULP [2.185, 3] CD [0.98, 1.12] HC [7120.4, 7810] LD-GAS [1.27, 4.12]
184.01	CH [1.67, 1.79] ENT [3] SULP [1.7, 2.185] CD [0.98, 1.12] HC [7120.4, 7810] LD-GAS [1.27, 4.12]
289.48	CH [1.78, 1.93] PW [297.2, 320.0] FCS [102.1, 121.9] CD [0.76, 0.98] HC [7120.4, 7810] LD-GAS [1.27, 4.12]

2.3. Modular CMM emission prediction methods

Empirical methods of estimating methane emissions in underground coal mines require only a few parameters, but using empirical methods can sacrifice the accuracy of the results. In order to provide more accurate results as well as to conduct sensitivity studies, a modular software suite Methane Control and Prediction (MCP) was created to predict CMM emissions from longwall mines.

The MCP version 2.0 (and its earlier versions) was developed under the MS Access™ shell environment using artificial neural networks and various statistical and mathematical techniques. Dynamic link libraries (DLLs) written in C++ are used to process data for calculations. This software is available for download from <http://www.cdc.gov/niosh/mining/products/product180.htm> (Karacan, 2010). The software suite predicts CMM output from the ventilation systems of longwall mines using a database of information about these operations, including basic coal, mining, longwall panel, productivity, and coal bed characteristics. The software provides deterministic and stochastic options for CMM prediction and has U.S.-specific and more general site-independent models. Fig. 3A and B shows the input screens of models for U.S. and for international conditions, respectively.

MCP users need to enter the input parameters as realistically as possible for their particular operation. The modules are most accurate within the given min–max range, but there is some extrapolation flexibility in the calculation methods, allowing the modules to perform predictions beyond the minimum and maximum limits. When the entered data are beyond the limits, the program provides a warning and asks the user whether he/she would like to continue with the calculations. If the user approves, the program continues with its calculations. Dougherty and Karacan (2010) present application and sensitivity studies by varying input parameter values in MCP.

Aside from the various methods and their accuracies and adequacies for predicting the CMM emissions in underground coal mines, from ventilation and mine safety points of view, there are also different numbers speculated as to what level of specific emission is high or manageable. For instance, Thakur (2006) indicates that mines with specific emissions of $28.3 \text{ m}^3/\text{ton}$ ($1000 \text{ ft}^3/\text{ton}$) can be considered gassy, but that mining can be sustained with the help of a well-planned ventilation system. However, mining with specific emissions exceeding $28.3 \text{ m}^3/\text{ton}$ becomes economically unfeasible due to ventilation costs and also becomes unsafe, as it may be difficult to stay within statutory methane limits. The author suggests that operations with specific emissions in excess of $28.3 \text{ m}^3/\text{ton}$ should use methane drainage in support of ventilation. He further suggests that mines with specific emissions exceeding $113.2 \text{ m}^3/\text{ton}$ ($4000 \text{ ft}^3/\text{ton}$) can be safely operated with a well-designed degasification system in addition to a well-designed ventilation system.

Mine Ventilation Emission Prediction Model Input

Select the appropriate state and enter a value for each parameter below and click Run Model to view results.

Select a state:

	Min Value	Mean Value	Max Value
Seam height (inch):	39	81	280
Cut height (inch):	42	78	155
Panel width (ft):	400	820	1450
Number of entries:	2	3	5
Face conveyor speed (ft/min):	180	278	450
Stage loader speed (ft/min):	210	353	600
Total gas content of coal (scf/ton):	10	224	590
Coal production (million tons/year):	0.1	3.3	11.2

Mine Ventilation Emission Prediction - Stochastic Approach

Enter a value for each parameter below and click Run Model to view results.

	Min Value	Mean Value	Max Value
Seam height (in):	45.5	145.8	259.5
Cut height (in):	48	103.7	156
Panel width (ft):	414.2	768.3	1450
Panel length (ft):	1405.8	7087.5	12997.8
Overburden (ft):	300.1	1471	2519.4
Entries:	2	3	5
Cut depth (in):	28	36	44
Face conveyor speed (ft/min):	77.7	242.9	411
Stage loader speed (ft/min):	227.5	392.1	560.1
Total gas content of coal (scf/ton):	33.6	310.1	575.3
Sulphur content (%):	0.4	2.4	4.3
Heat value of coal (BTU/lb):	9753.4	12501.1	14899.2
Ash content (%):	4	16.8	29
Daily coal production (Mtons/day):	0.6	16.5	30.4

Fig. 3. Input screens of CMM prediction models of MCPs version 2.0 for longwall mines in specific states in the U.S. (A), and the stochastic model for longwalls assuming international settings (B).

3. Degasification of coal seam and capture of coal mine methane

Methane emissions can adversely affect both the safety and the productivity of underground coal mines. As mining progresses into gassier coal beds, mine operators have become more interested in methane control systems to supplement conventional ventilation methods and keep the specific emissions of the mines at low levels.

Methane emissions from the face, ribs, and conveyor belt are directly exposed to the mining environment and thus the ventilation system must have sufficient capacity to handle any unexpected increases in methane emission levels from these sources. As mines move into deeper and gassier coal beds, and as longwall operation parameters change, emissions that flow directly into the ventilation system may increase. To address this issue, the most common supplemental gas management practice is the degasification of the coal bed prior to mining to reduce the amount and rate of these emissions. In addition to reducing the in-place gas content of the coal bed, it has been shown that methane drainage is also effective for reducing the risk of gas outbursts by decreasing the pressure of the coal bed in the vicinity of the mine workings (Noack, 1998).

In addition to methane emissions from the face, ribs, and conveyor belt, the other source of methane is the fractured and caved rock in the

subsidied strata (gob) overlying the extracted panel. The subsidied strata are generally made up of a completely caved zone overlain by strata with extensive fractures. The height of the caved zone is about 3 to 6 times the thickness of the mined coal bed (Palchik, 2003). The stress relief due to caving causes the overburden strata above the caved zone to fracture vertically and horizontally, as high as 100 times the height of the mined coal bed, depending on the size of the panel, the geology, and geomechanical properties of the layers (Palchik, 2003).

Emissions from the fractured zone are usually controlled by gob gas ventholes. However, the stress-relief fractures that occur during longwall mining provide extensive pathways for gas migration from the surrounding coal beds and other gas-bearing strata into the active mining environment. The migration of methane into sealed and active areas depends on the gas contents of the overlying formations and the presence of methane accumulations, as in abandoned workings or gobs. These emissions can occur suddenly with large gas quantities rapidly inundating the ventilation system and changing the properties of the mine atmosphere in large areas. Therefore, it is important to be able to know the size of the fractured zone, or "methane emission zone," in relation to the design of gob gas ventholes.

Methane drainage boreholes, whether they are horizontal, vertical, or gob gas ventholes, directly communicate with methane sources and gas migration paths, and with both active and sealed mine areas. Therefore, analyses of borehole production and operating pressure data can provide more information than just the amount of methane produced. Actually, these analyses can offer insights into the gas transport properties of the methane sources in question, the interaction of drainage boreholes with methane sources, the extent of the borehole-effect radius, the boundaries of the methane source, and the optimum duration of borehole operation prior to mining. This information can eventually determine the interactions of the borehole/methane sources/mine environment trio to evaluate the observed methane level changes in the mine's ventilation system. Migration and control of methane gas levels are best accomplished by measuring in-mine gas levels and by considering the interactions of sealed and active gobbs with a mine's ventilation system, the drainage radii of boreholes, and the properties of the gas sources.

The selection of an effective methane control system depends on the sources of the gas emissions. The most commonly applied methane control solution, especially in high in-place gas content coal beds, is drilling methane drainage boreholes into the panel area prior to longwall mining to reduce the methane content of the coal bed. These boreholes can be vertical or horizontal boreholes drilled from the surface, or in-seam horizontal boreholes drilled from the underground entries (Diamond, 1994). Although in-mine drilling can be challenging due to the logistics of working in the restrictive underground environment, one advantage is that virtually the entire drilled lengths of the boreholes are in the gas-producing horizon of the mined coal bed.

In recent years, a new pinnate-drilling™ technique has been successfully applied in coal beds in the Appalachian basin and in the western states of the U.S., including the Arkoma basin (Spafford, 2007). This technique combines the logistically less complicated process of drilling from the surface with the high productivity of horizontal methane drainage boreholes. Also, these holes continue producing even though the single laterals may quit production due to various reasons.

This section reviews some of the most common borehole techniques used for degasification of coal seams and the gas emission zones of longwall panels, as well as some advantages and disadvantages associated with employing them. A good review of engineering and economic evaluation of gas recovery from mines using different boreholes is also given in Kirchgessner et al. (2002).

3.1. Degasification of coal beds using horizontal boreholes for reducing emissions

The purpose of and the design considerations for horizontal degasification boreholes may change depending on the mining conditions and on the coal bed. Generally, in-mine horizontal boreholes are used to perform two basic mine safety functions: reducing the in-place gas volume within the panel prior to mining and shielding active workings, especially development sections, from gas migration from the surrounding virgin gas reservoir. In-seam horizontal methane drainage boreholes are usually completed open hole, with a short segment (9–15 m) grouted to seal the end of the borehole near the mine workings. Long horizontal boreholes drilled parallel to the gate roads in advance of entry development can be utilized to drain methane from the panel area, and they also can be used to shield the advancing development entries from the flow of gas from the surrounding coal reserves.

In the late 1970s, four long horizontal boreholes were drilled into the Pittsburgh coal in Pennsylvania from a section of a mine that had been abandoned for 2.5 years due to high methane emissions. The lengths of the holes were 299 to 764 m. The average production rate of the holes was 9.3 m³/day/m of drilled borehole length and the cumulative production was 7.2 × 10⁶ m³. The production rate decreased

to 3.7 m³/day/m of borehole after 2.7 years of production. This project was unique at the time for two reasons. First, in the previous projects, the primary gas problem was emissions at the active face, and the gas produced by horizontal boreholes drilled near the face was vented to a location underground where enough air was present to dilute it. In this project, the gas was transported to the surface. Second, the transported gas was utilized to generate electricity from a turbine to power a ventilation fan. This may have been one of the first applications of utilizing coal gas for power generation.

Shorter cross-panel horizontal boreholes drilled from the advancing entries can also be used to drain gas in advance of longwall mining. These boreholes are drilled perpendicular to the rib to a location close to the opposite side of the panel. Although it has been reported that this technique successfully removed substantial amounts of methane from the completion end and the middle of the panel (Aul and Ray, 1991), gas-related mining delays were encountered at startup because the cross-panel horizontal boreholes in that area were in production for a relatively short period of time prior to the start of mining. Different strategies, such as placing the boreholes at the startup end closer together or drilling from the tailgate side into the virgin coal bed beyond the panel as the entries advance, can be considered to improve their effectiveness.

Continuity and permeability of the coal seam significantly affect the success of methane drainage boreholes. In high-permeability coals, in-mine horizontal boreholes can be used for shielding the gate road entries to maximize gate road development, for reducing in-place gas content of longwall panels, and thus for promoting maximum longwall mining advance rate (Bohan, 2009). The impacts of shielding the gate road entries on methane emissions and on reducing ventilation airflow rates, as well as on improving mining advances, are given in Fig. 4.

The importance of shielding the gate roads and its effects on emissions with respect to the presence of boreholes and their proximities to entries was also demonstrated by Karacan (2007a,b). The author considered various mining and degasification parameters in a systematic manner to predict methane inflows into gate roads and associated airflow requirements. The predictions were compared with the in-mine measurements available from the mining of tailgate and headgate entries. The general results indicated that for shorter development distances, marginal adjustments in ventilation airflow may be adequate to keep methane levels under 1%. However, longer gate road developments require significantly more ventilation air capacity to keep methane levels constant, proving that shielding boreholes is more important in this case. Thus, employing shielding boreholes to protect entries from methane migration during mining is an effective approach. Even if the boreholes cannot be operated for a long time prior to the start of mining, their presence during mining makes a big difference (about 25%) in methane inflow rates, especially during mining of longer sections. In this context, positioning of boreholes relative to entries is important. Positioning wellbores as close to the entries as practically possible is effective, especially while mining long development entries at higher advance rates. Fig. 5 illustrates the ventilation air requirements for entry development as functions of methane levels, entry lengths, and advance rates without using shielding boreholes during mining of a 2.3-m-thick seam (Karacan, 2007a,b). This figure shows that as the lengths of the developments and the advance rates increase, the required air quantity to keep methane concentrations at lower levels increases substantially.

In addition to the presence of boreholes for sustainability of mining under safe and productive conditions, a coal seam's reservoir properties also have a big impact on the productivity of these boreholes and their effectiveness (Karacan, 2008a,b). Among all the coal bed parameters evaluated for their effects on methane inflow into gate roads during their development, coal bed thickness, pressure, sorption time constant, permeability perpendicular to entries, and adsorption parameters were found to be the most influential on

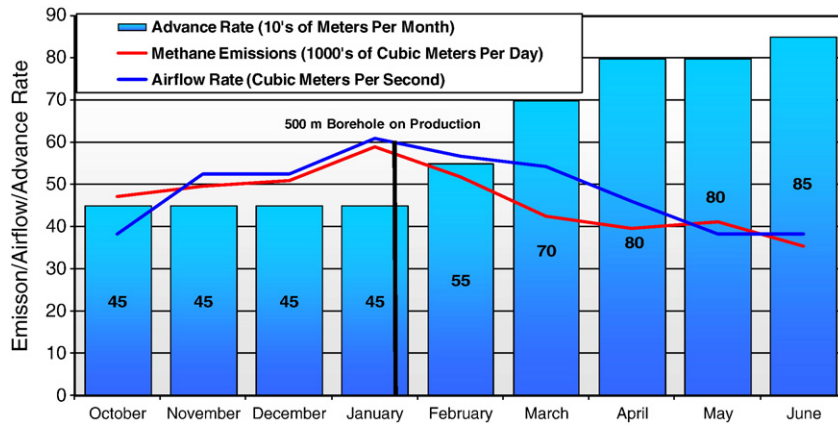

Fig. 4. Immediate impact of a 500-m shielding borehole along the gate road on emissions, advance rate, and ventilation air requirement (Bohan, 2009). Courtesy of REI Drilling.

methane inflow rate. For shorter development distances, initial water saturation was also found to be influential. Statistical analyses (ANOVA) to evaluate the significance of these parameters showed that, for all development distances, pressure, sorption time constant, permeability perpendicular to gate roads, and Langmuir pressure were more important independent variables for prediction by comparison to Langmuir volume and coal bed thickness. Further, it was shown that as the development distance increased, the order of the relative importance of coal bed variables changed (Karacan, 2008a,b).

Other examples where long and cross-panel boreholes are used to reduce in-place gas content are given in Fig. 6A and B. In Fig. 6A, multi-lateral horizontal boreholes are drilled from a single drilling location in the panel area before mining. In Fig. 6B, boreholes drilled from various locations in the mains extend into multiple panel areas to drain the gas in a larger area before mining commences. Multiple wells can be connected together as shown in Fig. 7 for gas gathering and transportation within the mine.

One of the most important aspects of methane drainage using any pattern of boreholes is estimating the amount of lead time required to reduce the in-place gas volume sufficiently to effectively control gas emissions during longwall mining. The importance of drainage time in reducing methane content of the coal was reported by Aul and Ray

(1991). The authors noted that only 30% of the gas could be removed from longwall panels in the Pocahontas No. 3 coal bed if the drainage time were about 2 months. However, horizontal boreholes that produced for about 10 months were able to drain 80% of the in situ gas. Based on these data, the authors concluded that at least 6 months was required to drain sufficient quantities of gas to have a positive impact on methane emissions during mining. As a result of the horizontal borehole methane drainage program, ventilation airflow along the longwall face was reduced from 3420 m³/min (120,000 cfm) to 720 m³/min (25,000 cfm).

The life of horizontal boreholes is dependent on the mine plan. Typically, 6 to 12 months of gas production prior to mining is required to sufficiently degasify an outlined longwall panel. Horizontal boreholes drilled near the recovery rooms are usually allowed to produce gas even after mining starts. However, as the longwall face approaches these borehole locations, gas production is generally terminated as a safety measure by injecting water or some other material into the borehole to block the flow of gas. Thus, there are two phases in the production history of a horizontal borehole: prior to mining and during mining. The relative gas production contributions of these two phases will vary considerably depending on the well configuration and spacing, duration of pre-mining drainage, and rate of mining. Karacan et al. (2007a) investigated the benefits of various borehole patterns and the pre-mining degasification durations. Results of this study showed that dual and tri-lateral boreholes were more effective in decreasing emissions and in shielding the entries compared to fewer shorter, cross-panel, horizontal boreholes parallel to the longwall face. Modeling results showed that after 12 months of pre-mining methane drainage, the average longwall face emission rates could be reduced by as much as 10.3 m³/min and 6.8 m³/min using tri- and dual-lateral boreholes, respectively. It was also shown that if pre-mining methane drainage time were short, it is important to continue methane drainage during the panel extraction to maximize reductions in longwall face emissions, since additional face emission reductions achieved during this period can be comparable to pre-mining degasification. Fig. 8 shows (as an inset) the studied horizontal methane drainage borehole patterns for degasification of the longwall panel and their performances during different phases of degasification, after 3 months (solid fills) and 12 months (patterned fills) of pre-mining degasification.

3.2. Capturing methane from longwall gobbs using vertical (gob gas venthole) and cross-measure boreholes for reducing emissions

The formation of gob (for both the caved zone and fractured zone) during longwall mining creates stress relief and resultant rock damage. This changes the gas flow-related properties, particularly the permeability, in the overlying (and in some cases the underlying)

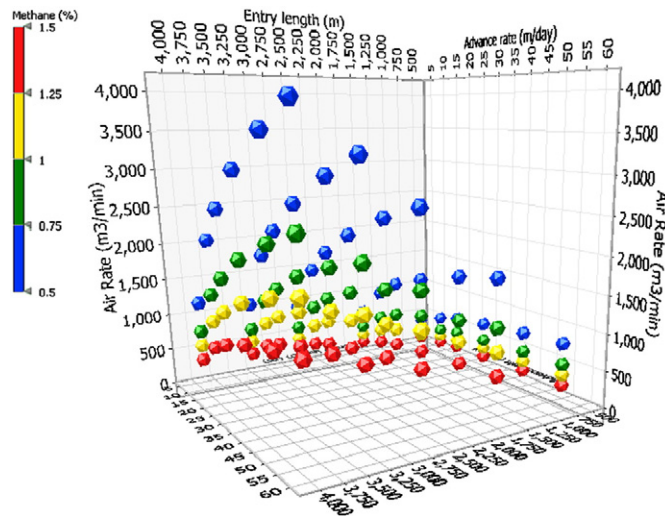

Fig. 5. Airflow required for entry development to keep methane levels under certain limits for variable entry lengths and advance rates without shielding boreholes during mining of a 2.3-m-thick seam. Y-axis is advance rate in m/day.

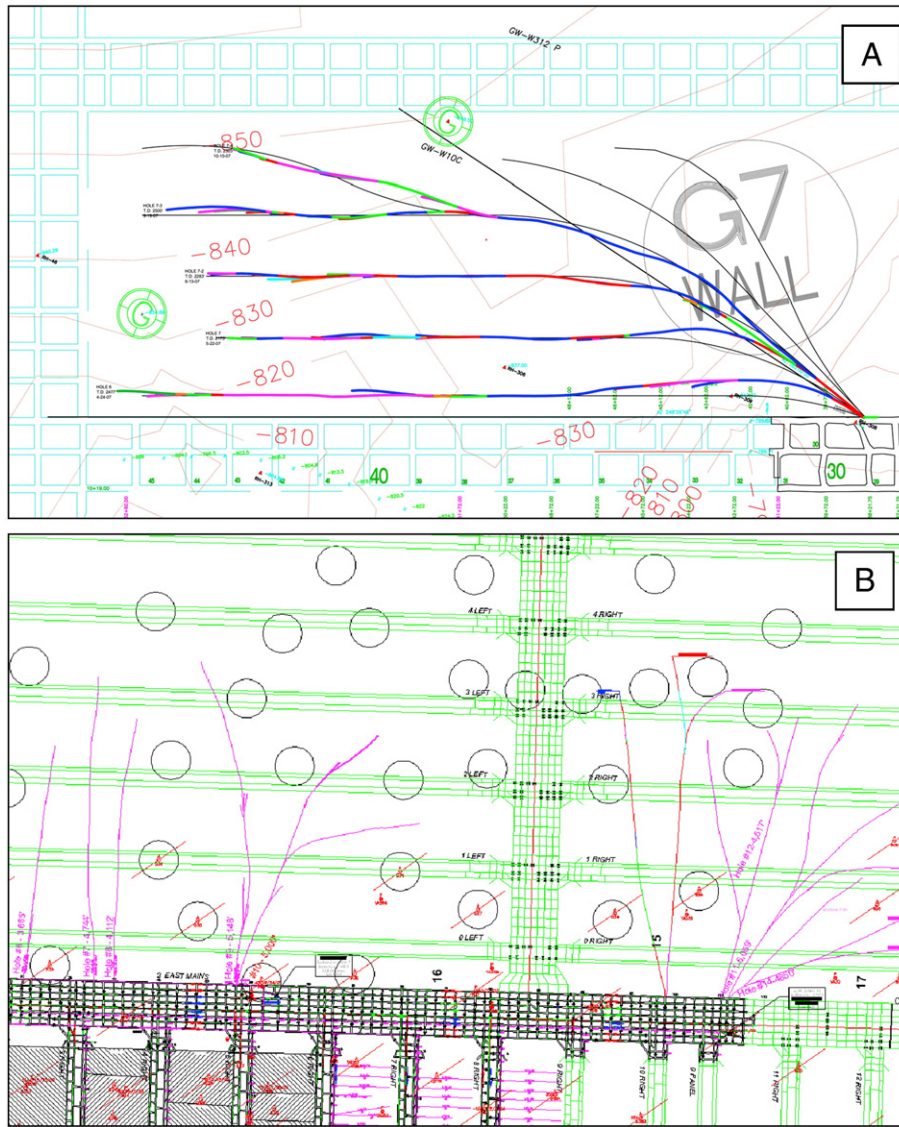

Fig. 6. Examples of using horizontal boreholes to reduce the in-place gas content of longwall panel (Bohan, 2009). Courtesy of REI Drilling.

strata (Karacan and Goodman, 2009). Any gas that is contained within the coal beds and other gassy formations in this area of relieved stress will be released slowly over time. The free gas in porous formations, such as sandstones, will be released more quickly, as the permeability

of these zones is dramatically increased and as new permeability pathways are created.

Relaxation of the roof and floor rocks and creation of the associated fracture connectivities allow gas to flow from all surrounding gas sources toward the low-pressure sink of the underground workings, including the caved zone. In the absence of methane drainage boreholes such as gob gas ventholes or boreholes drilled from the mine entry up into the roof rocks (cross-measure boreholes), this released gas, commonly referred to as “gob gas,” may enter the mine atmosphere from above.

3.2.1. Longwall gob gas ventholes

Gob gas ventholes are drilled into the overburden above longwall panels to capture the gas released from the subsided and relaxed strata before it enters the mining environment, where it can be an explosion hazard. Most gob gas ventholes are drilled within a short distance, 10–30 m (30–100 ft) of the coal bed being mined, and cased with steel pipe. Commonly, the bottom section of the casing – generally about 60 m (200 ft) – is slotted and placed adjacent to the expected gas production zone in the overburden strata. The usual practice is to drill the gob gas ventholes from the surface prior to mining. As mining advances under the venthole, the gas-bearing

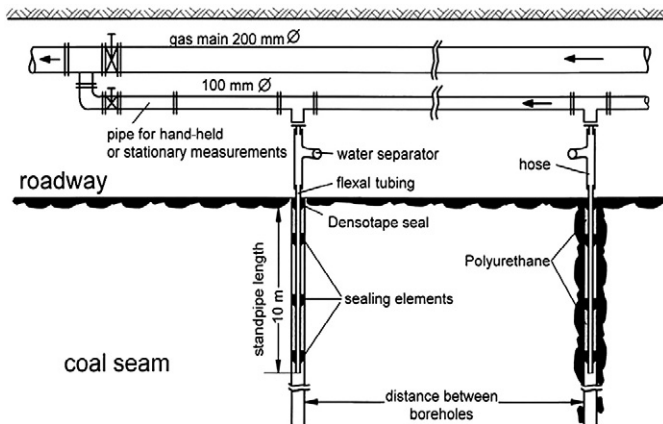

Fig. 7. An underground connection schematic of pre-drainage boreholes (Noack, 1998).

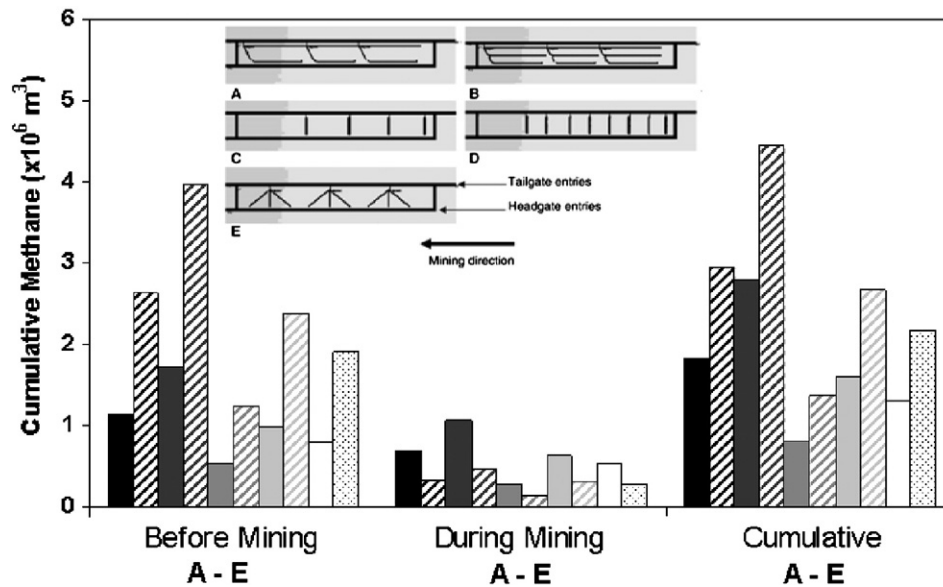

Fig. 8. Horizontal methane drainage borehole patterns and their performances after 3 months (solid fills) and 12 months (patterned fills) of pre-mining degasification.

strata that surround the well will fracture and establish preferential pathways for the released gas to flow towards the ventholes. Exhausters are placed on gob gas ventholes to maintain a vacuum on the wellbore, so that they operate at the minimum possible flowing pressure and create a pressure sink in the overburden strata to induce gas flow towards the venthole.

Gas production from gob gas ventholes may exhibit variable gas quality. In the early stages of production, the gas quality is generally high (>80%), and there is very little contamination by mine ventilation air. Maximum daily methane production generally occurs within the first several days after a hole is intercepted by the longwall. Relatively high production rates are usually sustained for only a few weeks or in some cases for a few months (Diamond, 1994). Later in time, gob gas production may exhibit decreased methane levels as ventilation air is drawn from the active mine workings.

The quality of the gas from gob wells can be controlled to some extent by varying the vacuum on the well to correspond with the profile of expected methane release. However, maintaining the methane concentration in the mine within statutory limits is always the overriding factor for controlling the vacuum on the gob gas ventholes, as it is for all other mine-related methane drainage systems. Commonly, when the methane concentration in the produced gas reaches 25%, the exhausters are de-energized as a safety measure, and the holes may be allowed to free-flow.

The location of the ventholes on the panel is important. A study in a coal mine in the Lower Kittanning seam showed that holes placed near the gate roads of the panels were generally the highest-quantity and longest-duration producers. This was attributed to enhanced mining-induced fractures on the ends of the panels where the overburden strata were in tension on three sides due to the support of the surrounding pillars. This observation led to the experimental placement of gob gas ventholes in the zone of tension along the margin of a panel, instead of in the traditional centerline location, which is in compression due to subsidence and re-compaction of the longwall gob. Analysis of seven months of gas production data indicated that the experimental near-margin holes produced 77% more gas than did centerline holes on the same panel (Diamond, 1994).

Improvements in venthole gas drainage evaluation and prediction capabilities for site-specific mining conditions and circumstances can address longwall gas emission issues, resulting in ventholes designed for optimum production and mine safety. To improve gas capture at a reasonable cost, it is important to understand the behavior of the

entire gob gas venthole system, including the venthole placement and completion strategies, the reservoir properties of the gob in the caved zone behind the face, the fractured rock mass around the workings, and, finally, the ventilation system. A theoretical reservoir modeling approach is the best, if not the only, means to predict methane emissions in advance of mining (Noack, 1998) under varying conditions. Such an approach can also permit design of drainage systems for either reducing the chance of unexpected methane emissions or for responding more quickly and effectively to unknown conditions encountered during longwall mining.

Keeping the other completion parameters constant, increasing the gob gas venthole diameter usually increases cumulative methane production from the subsided strata. Although a marginal decrease in the methane concentration can be observed from this completion change, possibly due to increased mine-air extraction with a larger sink, the increased gas flow rate increases the overall volume of methane produced when a larger diameter is used. Casing setting depth also plays an important role in the amount and concentration of methane captured. If the setting depth is close to or within the caved zone, the methane concentration in the produced gas and total amount of methane captured decreases. Increased casing setting heights above the mined coal bed result in more cumulative methane production (Karacan et al., 2007b).

One additional consideration for changing the setting depth for the slotted casing may be the competency and productivity of the formations surrounding the slotted casing. For example, if the mechanical properties of the immediate strata above the coal bed at one site are different from those at another site (caused by the presence of a sand channel, for instance), a different caving height and fracturing height may be expected as a result of longwall mining. Thus, the slotted casing setting depth may need to be adjusted accordingly. Similarly, if there are layers with appreciable gas emission potential (such as thin rider coal beds), this may also be a consideration to capture the optimum amount of gas by changing the setting depth of the slotted casing. These considerations require a good understanding of the gas emission zone above and below the mined coal seam based on the mining and geotechnical conditions of the immediate strata.

The gas emission zones predicted by different researchers are given in Fig. 9A and B. These graphs show the degree of gas emissions as a function of varying distances from the mined coal bed in overlying and underlying formations. It is not clear, however, whether these profiles are applicable to all conditions. It is reasonable to expect that the

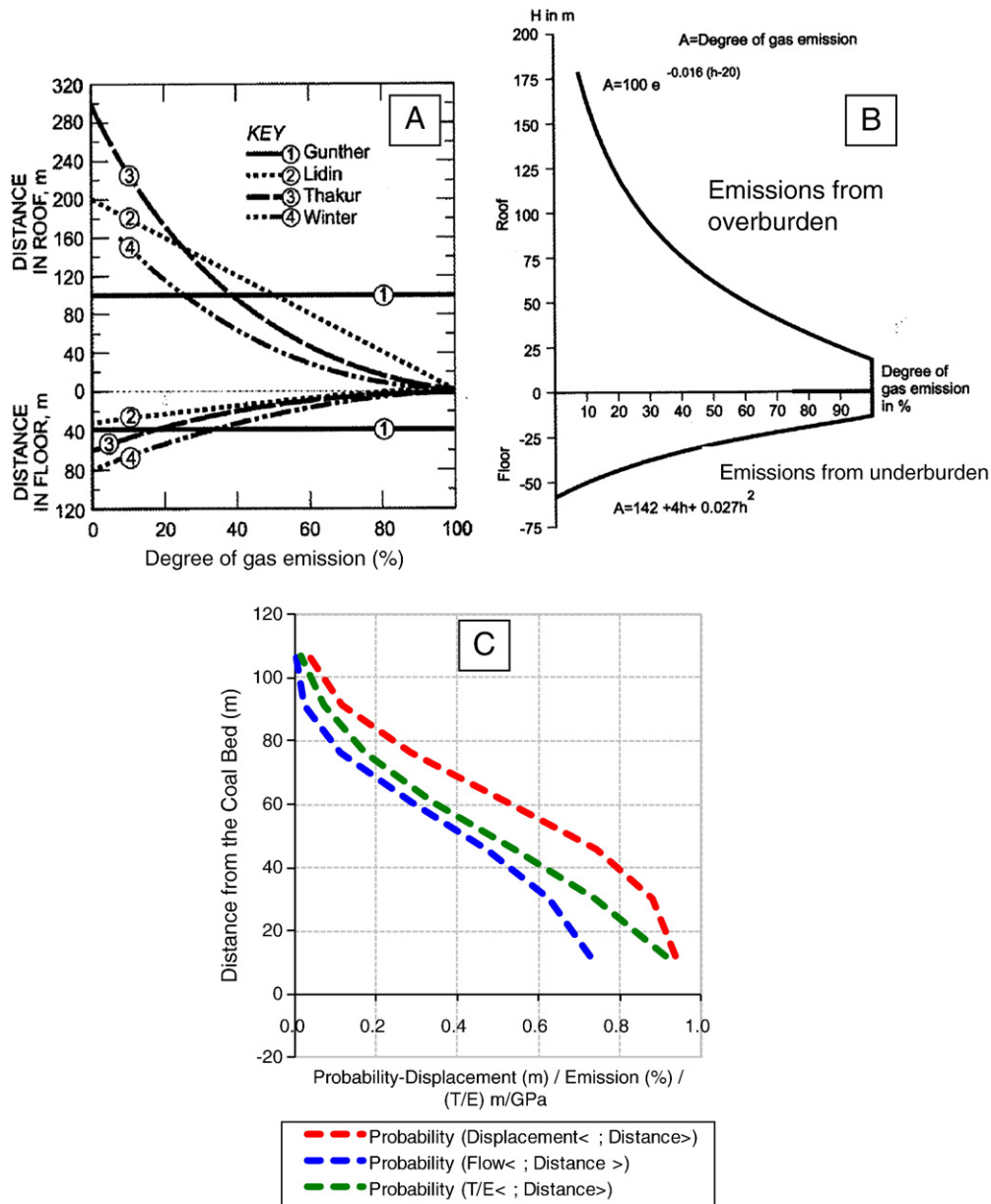

Fig. 9. Gas emissions zones for longwall gob gas. From Thakur (2006), Noack (1998) and Karacan and Goodman (2011a).

size of the gas emission zone and the emission profiles are very much dependent on local geology and the characteristics for formations. Further, there is always some uncertainty associated with the unknowns in the overlying and underlying formations and with how they may react to mining disturbances. Thus, a site-specific and probabilistic approach to define the gas emission zone might be a better technique for placing slotted casing and controlling emissions. Fig. 9C (Karacan and Goodman, 2011a) shows a probabilistic method to estimate the size of the gas emission zone based on various parameters. Fig. 9C presents the probabilities of having less than 0.6-m displacement, with 90% of the emission and a ratio of strata thickness to Young's modulus (T/E) of 15.2 m/GPa at various distances above the coal of longwall mines in the Northern Appalachian basin. This figure shows that a gob gas venthole drilled to within ~13 m (45 ft) above the coal seam and completed with a 61-m (200-ft) slotted casing should be capable of withstanding strata displacements of less than 0.6 m, especially at lower sections, as the probability of having that much disturbance is 0.8–0.9. In addition, the probability of capturing less than 90% of strata emissions with this borehole is ~0.5 with a 61-m long casing. Similar probabilistic esti-

mations for gas emission space can be made for other sites and for various values of emissions and displacements. This methodology is described in Karacan and Goodman (2011a).

In addition to the size of the gas emission zone, it is important to be able to predict the properties of the gas reservoir (gob) created by mining disturbances and to optimize the gob gas venthole parameters and placement accordingly. Unfortunately, a standard approach does not exist to evaluate the properties of gob and to properly design the ventholes. Transient well tests analysis methods, such as multi-rate drawdown and interference and pressure buildup tests that are applied in the petroleum and natural gas industry and in coalbed methane reservoirs, can be options to understand the characteristics of the gob reservoir and the interaction of gob gas ventholes (GGVs) with the gob and mining environment. The results of these tests can be used to determine parameters such as skin, permeability, radius of investigation, flow efficiency, and damage ratio.

The insights obtained from well test analyses can be used for a better understanding of the gob and for designing more effective GGV systems. However, the difficulty associated with application of

well tests is that certain reservoir geometries, boundary conditions, and flow regimes should be determined or assumed in the absence of relevant measurements. For instance, Karacan (2009b) analyzed the production rate-pressure behaviors of six GGVs drilled over three adjacent panels by using conventional multi-rate drawdown analysis techniques. The analyses were performed for infinite acting and pseudo-steady state flow models, which may be applicable during panel mining (DM) and after mining (AM) production periods of GGVs, and by radial flow models in composite homogeneous gob reservoirs in the absence of strata separation data. Shown in Fig. 10A and B is the flow potential versus logarithm of superposition time for a gob gas venthole's DM and AM production periods, respectively. These phases were analyzed separately since the reservoir properties, due to dynamic subsidence, boundary conditions, and gas capacity of the gob reservoir may change between these two stages. The results indicate that reservoir properties of the "homogeneous" gob and well productivities could be determined using these techniques. For instance, permeability was determined to be around 3–5 darcies. The importance of such analyses is that they give an indication of the reservoir conditions of a longwall gob and the productivity of the GGVs. This information eventually can be used for borehole completion designs and borehole drilling spacing. Results also can be used to make forecasts related to long-term productivity of GGVs.

Similar techniques can be used if the presence of strata separation is known and measured within the gob. Karacan and Goodman (2011b) analyzed the multiple rate data of a GGV tested in such an environment. However, since the existence of bedding plane separation was known and its thickness and location were known, the model was set up for an infinite acting fracture where the flow field was linear towards the wellbore in the separation zone. Dual porosity was assumed in the overlying and underlying gob zone. In the study, the boundary conditions of the gob (except for the separation interval) were changed from no-flow to infinite to observe the differences in determined reservoir properties. Interestingly, neither the properties of the

separation interval nor the properties of rest of the gob changed. Permeability of the bedding plane separation was close to 90 darcies, whereas the dual porosity section was determined to have permeabilities of 200–300 mD (0.2–0.3 darcies). The permeability calculated for the separation interval was in agreement with literature data. Comparisons of the permeability data of this study with Karacan (2009b) suggest that assigning homogenous properties to the gob, in the absence of strata-separation information for well test analyses, averages the permeability within the entire producing interval.

Well test techniques described above can also give an idea about the effective approximate drainage radius of the boreholes drilled in longwall gobs. For the two case studies described in the previous paragraphs, the average drainage radii varied between 300 m and 2000 m, depending on the location of the wellbores. This information can be helpful for both maintaining mining safety and for using such boreholes for effective production of coal mine methane.

The above discussions briefly illustrate the challenges of designing and operating gob boreholes under various controllable and uncontrollable conditions. Karacan (2009a) and Karacan and Luxbacher (2010) discuss the major factors that affect GGV productions and design parameters. In order to address these challenges and to provide mine operators with a practical tool, Karacan (2010) developed software [MCP version 2.0] (<http://www.cdc.gov/niosh/mining/products/product180.htm>) that is capable of predicting production rates and methane concentrations from GGVs operating in active and completed longwall panels. The software was developed using deterministic and stochastic methods, so each output associates with a percentile value to indicate its place in the entire solution domain that was considered. Fig. 11A gives a snapshot of the output for a GGV operating in an active longwall with an overlying gas source in a low-medium volatile coal. Fig. 11B shows the variations in methane concentrations and their percentiles that can be obtained from a GGV under various operating conditions in active (A–A) and completed (C–I) panels with different gas sources in the gob.

3.2.2. Cross-measure boreholes

Cross-measure boreholes are drilled with various design principles for the purpose of draining roof and floor rock strata as they relax during mining. In Europe, due to the greater depths of the longwall mines, cross-measure boreholes are preferred over GGVs. These boreholes are drilled at an angle over the longwall panel and oriented away from the advancing face so that they drain gas from the entire length of the relaxed zone on the return air side of the panel. Generally, cross-measure boreholes drilled behind the longwall face achieve higher production efficiencies and maintain higher gas purities than those drilled in front of the coal face.

In longwall mining operations, strata below the mined seam may be a major gas source, too, if they contain gassy seams or gassy sandstones. In these situations, one advantage of cross-measure boreholes compared to GGVs is that they can be drilled at an angle into the strata below the mined coal bed to drain the gas of underlying formations so it does not enter the mining environment. The angle of cross-measure boreholes may vary from 20° to 60° from horizontal. At least one hole is drilled at each site (Thakur, 2006), but hole inclination and spacing can be different based on the gassiness of the floor and roof as well as geotechnical considerations for hole stability (Whittles et al., 2006, 2007).

Whittles et al. (2006) conducted geomechanical modeling research, augmented with field measurements, on a retreat longwall coal panel at Thoresby mine, UK, where methane drainage using cross-measure boreholes was undertaken for safe working conditions. Boreholes of 75-mm diameter were drilled at regular spacings into the roof and floor of the tailgate roadway inclined at an angle of 60° over the longwall gob. The panel was at a depth of approximately 770 m and 270 wide. The models predicted that there was a lack of connectivity of gas flow paths from the gas sources into the active workings, which prevented gas inflow. Based on this observation, the

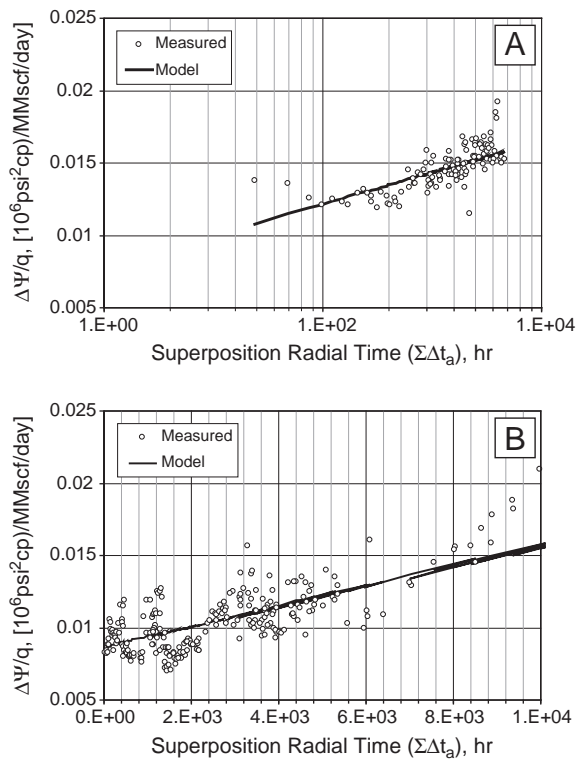

Fig. 10. Analyses of two different production periods of a gob gas venthole (infinite acting: A, and pseudo-steady state: B), using flow potential versus logarithm of superposition time in multi-rate testing.

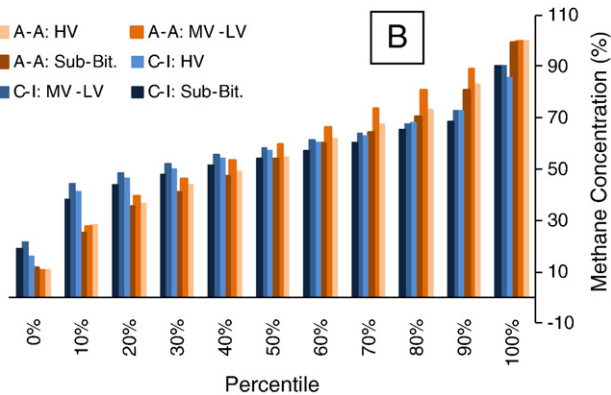
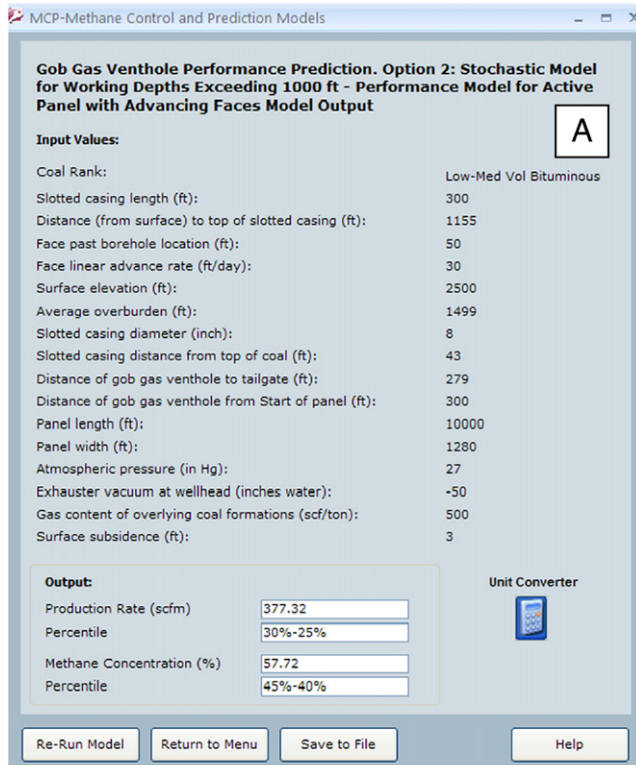

Fig. 11. A snapshot of the output screen from MCP 2.0 for a gob gas venthole operating in an active longwall panel (A) and the percentiles corresponding to different methane percentage outputs from conditional MCP simulations of gob gas venthole production (B).

researchers speculated that coal seams that are disturbed by mining above the longwall panel are unable to release their gas into the mine if the intermediate strata layers are not fractured. Therefore, it was proposed that if the cross-measure boreholes can be extended into these coal seams, they may be producing substantially more gas.

In order to obtain an effective drainage of mine gas, sealing of the casing collar in cross-measure boreholes is very important. A smaller-diameter liner is inserted and cemented at the borehole collar to maintain the production. The gas produced from cross-measure boreholes may vary in rate and concentration depending on the sealing of the borehole and gassiness of the gob. However, in any case, these boreholes are connected to a larger pipeline system underground and the gas is withdrawn with a vacuum system. Fig. 12 shows an example of a typical gas-gathering system for cross-measure boreholes.

3.3. Degasification borehole stimulation, stability, and completion issues

Stability and completion of boreholes is very important to effectively capture methane so as to ensure the safety of the underground

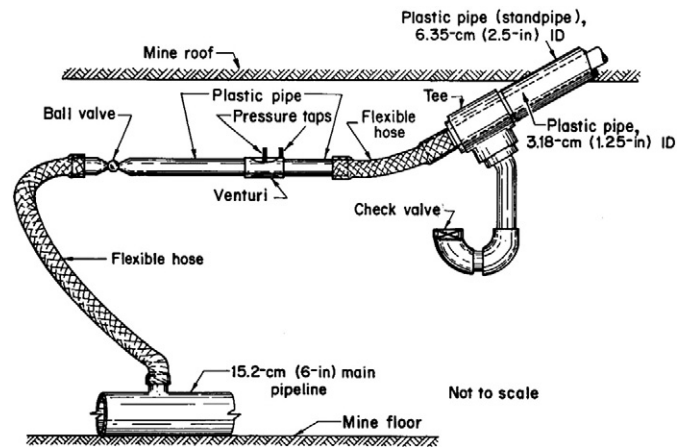

Fig. 12. Example of typical gas-gathering system for cross-measure boreholes. From Diamond (1994).

workforce and to provide sufficient quantities of gas for possible utilization purposes. This section covers some important aspects of stimulation, completion, and stability related to various boreholes.

Coal is usually less permeable than conventional sandstone reservoirs. Therefore, in order to effectively drain and capture coal bed and coal mine methane, some kind of treatment (stimulation) is usually needed to enhance the permeability around the borehole for some distance into the coal. However, there has not been much consensus on what type of treatment should be used. This is partly due to the fact that the role of permeability in coal gas recovery and in well completions has not been fully appreciated (Palmer, 2008).

Numerous published studies detail the stimulation and completion of boreholes drilled into coal seams in various basins (Cameron et al., 2007; Holditch, 1990; Palmer and Cameron, 2003), with some specific strategies recommended. For instance, water-jetting has been proposed as a stimulation technique to improve permeability and to improve safety as well as productivity of the mining operation through effective gas drainage (Lu et al., 2009). A water-jet cutting system helps create artificial slices in the coal to increase its permeability for improvement of methane drainage. Palmer (2010), after collecting data on coal gas production worldwide, discussed the role of permeability in choosing well completions. He defined permeability bands as ranges of coal permeability in which certain well completion types can be preferred. He suggested that coal permeability in the coal seam to be produced or mined should be defined and that well completions should be selected accordingly. In effect, this approach leads to a decision tree which includes various completion options as a function of the coal permeability.

Since the approach proposed by Palmer (2010) is based on permeability, a permeability map of the coal seam should be generated as completely as possible, with a large number of measurements that will yield a valid statistical distribution. This is important because permeability changes considerably due to the inherent variability in coals as a result of the orientation of stresses, lithotypes, and rank, in addition to other factors such as cleats and their origins. A good review of cleat and fracture systems in coal is given in Laubach et al. (1998). A general assignment of completions based on permeability is shown in Fig. 13.

From a coal mine methane management point of view, multiple seams in the gas emission zone may require horizontal wells in overlying and underlying seams, especially if the purpose is to degasify the emission zone and if the main source of gob gas is the coal beds. In this case, a hybrid completion technique can be considered based on a measurement of kH (permeability \times thickness) values in all seams. This selective stimulation is based on practical and economic seam productivity and can be prioritized. For instance, for a vertical

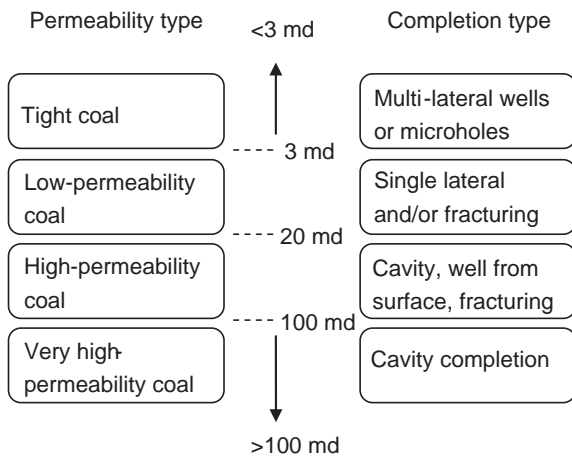

Fig. 13. Decision tree for various completion options as a function of the coal permeability. Modified from Palmer (2010).

borehole drilled to the main seam and with the seams within the gas emission zone, the coals with the lowest kH values can be avoided, whereas the highest kH seams can be completed with horizontal boreholes and the mid-range seams can be stimulated by fracturing. This procedure is illustrated for a hypothetical well in Fig. 14. A good review of permeability and completions criteria is given in Palmer (2010).

Stimulation of a vertical or horizontal coal mine methane (or coalbed methane) well is often associated with hydraulic fracturing to facilitate higher gas production rates. This method can be especially effective if there is not much lead time to degasify the coal bed prior to mining. Hydraulic fracture growth usually occurs perpendicular to the least principal stress. For instance, if the least principal stress is horizontal, the hydraulic fracture growth is usually vertical. A vertical fracture of a CMM well that extends beyond the thickness of the coal seam may be a concern for two reasons. First, the roof rocks of the future longwall or room-and-pillar operation may be damaged and create roof control problems during mining. Second, those wells with high vertical fracture growth may experience exceptionally high water productions that hinder gas production and effective degasification prior to mining. Colmenares and Zoback (2007) noted that in Powder River basin, Wyoming, the coal gas wells with excessive vertical growths produce large quantities of water, delaying gas production significantly. However, hydraulically fractured wells with

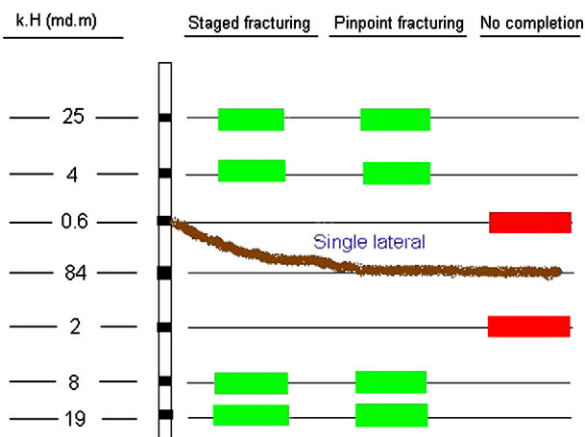

Fig. 14. An example of selective hybrid completion based on kH . In this figure, green bars represent the applicable completion techniques at different intervals, whereas red bars represent that no completion is needed for the specified coal horizons. Modified from Palmer (2010).

shorter vertical fractures and lower water productions are excellent gas producers, surpassing the gas production from horizontally fractured wells in the same seam. Thus, it is important to engineer and control hydraulic fracture directions and growths in CMM capture boreholes.

In order to ensure the capture of coal bed and coal mine methane effectively, stability of the boreholes drilled for these purposes is of critical importance. In CMM production boreholes, stability and reliability can be a significant problem because coal is a weaker material than sandstones and limestones, and the stress concentration around the boreholes may cause boreholes to fail easily. In addition, the stresses created by mining activities in the coal can lead to additional stresses and displacements in the formations surrounding the boreholes, which can lead to borehole failure. These situations are more severe when the boreholes are completed open-hole (not cased).

Borehole stability problems can cause stuck pipes, borehole enlargement (ballooning), poor cleaning, and deviation control when drilling horizontal holes in coals. In engineering practice, there are methods to test the stability of wellbores during drilling in formations of various strengths. These methods include the Mohr–Coulomb criterion with parameters based on triaxial test data to predict the polyaxial strength of rocks. However, Zhang et al. (2010) reported that this method under-predicts and is significantly conservative in estimating the minimum mud pressure required for ensuring wellbore stability. On the other hand, the authors reported that the Drucker–Prager criterion with parameters based on triaxial test data over-predicts the polyaxial strength of rocks and is unsafe in relation to estimating the minimum mud pressure required for ensuring wellbore stability. In the case of the 3D Hoek–Brown and Mogi–Coulomb criteria, the prediction errors were relatively small (Zhang et al., 2010); thus these were recommended as preferred methods.

Borehole stability issues may also arise during drilling and production of methane from the coal seams. Therefore, designing a drilling pressure based on the depth of the borehole and the type of formation is important. In addition to conventional rock strength and mechanics analyses that can be performed to assess the stability of boreholes, one should bear in mind that effective pressure (overburden pressure minus pore pressure) of the coal seam and the distribution of cleats may play a significant role on the normal stresses acting on the cleats and fractures in coal seams. Thus, if effective pressure changes suddenly in the immediate vicinity of the boreholes, the fractures may propagate and the borehole may fail suddenly. Therefore, drilling should be performed by adjusting the bottom-hole pressure, especially if the coal seam is permeable, so that the pore pressures do not change suddenly around the borehole. In the case of permeable coal seams, coal fines may also migrate easily and create a skin around the borehole within the cleats and fractures. This skin creates a time-delay effect (Qu et al., 2010) for re-establishment of effective pressure that should be taken into consideration to prevent failure of horizontal wells, particularly due to their length and the times necessary for their drilling and completion.

Gentzis (2009) conducted an experimental and modeling study specifically on coal samples for stability analysis of horizontal coal seam methane wells in the Mist Mountain Formation, SE British Columbia, Canada. The vertical stress gradient was calculated by integrating a bulk density log from an offset well. Horizontal maximum and minimum stresses were estimated from regional stress data, whereas formation pressure was estimated on the basis of a local hydrological study. The 2D elasto-plastic STABView™ numerical modeling code was used. Stability analysis was performed at bottom-hole pressures ranging from overbalanced to underbalanced (with drilling pressure greater than and less than formation pore pressures, respectively). This was done in order to simulate the conditions expected during drilling and production. It was concluded that when drilling at a 650-m depth in underbalanced to slightly overbalanced

conditions, there was a high probability of the drill pipe becoming stuck. On the other hand, when peak cohesion of coal was reduced by 50% to reflect the conditions expected along weak intervals of a horizontal wellbore, the predicted enlarged borehole was almost 85% greater than the designed well diameter under the same drilling conditions. The most unstable trajectory was perpendicular to the maximum horizontal stress in the study area. Modeling indicated that a production liner should be inserted immediately following the drilling of the horizontal well in this structurally complex geologic setting, since pressure drawdown and reservoir pressure depletion would lead to enlarged yielded zones and collapse of the wellbore over time.

In addition to geomechanical properties of formations and the geological stresses where the boreholes are located, drilling-fluid related issues may become a concern. For shallow wells or for wells drilled from gateroad entries, this may not be a critical issue, but for wells drilled from the surface into the coal seams, fluid invasion during drilling and completion operations can produce formation damage to low-permeability coals in the cleats around the wellbore. Laboratory tests conducted using large-diameter cores showed that the three different mud systems tested (Xantham Gum, HEC, and Na-CMC) did not negatively impact the coal permeability (Gentzis et al., 2009). The use of FLC 2000™ and Q-Stop in two field applications resulted in the successful drilling of 1400 m and 953 m of total horizontal length, respectively. During production, a small pressure drop was sufficient to remove the filter cake. Drilling was done in the deep Mannville coals in Alberta and at depths ranging from 1150 m to 1400 m. No borehole instability problems were encountered during drilling of the two horizontal wellbores. The mud losses were also low in both cases, with the horizontal well #2 experiencing lower mud loss. Horizontal well #1 remained stable, which allowed sufficient time for the insertion of a production liner.

Stability problems are more severe in GGVs and cross-measure boreholes since the strata displacements are unpredictable and can completely destroy the borehole, and can shear-off or bend the casing. For instance, two separate gob ventholes in Xieqiao mine in China, which began production with 30 m³ and 10 m³/min initially, ceased producing gas. Investigations for the causes of lost production showed that both the solid and the slotted sections of these wells were sheared at multiple locations along the borehole (Han et al., 2009). A similar situation was observed in the Zhangji mine (China). A well that started production with more than 40 m³/min ceased production after a week due to casing failure.

Whittles et al. (2007) examined Panel 44 of the Thoresby mine, UK, for the effects of the immediate roof geology and roadway support system on the integrity and effective life span of gas drainage boreholes drilled into the roof strata. The results obtained from the models indicated that the immediate roof strata would experience significant vertical and shear displacements where the magnitude of the movements were very dependent on the roof geology, which determined the roof movements. For a strong sandstone roof, the predicted movements were relatively small compared to the movements of a siltstone bed, where the roof movements were large. Above the immediate roof, it was noted that discrete horizontal shear planes at approximately four horizons could potentially intercept and rupture the borehole (Fig. 15). The initial failure of the standpipes due to horizontal rock shear was predicted at distances between 8.9 m for a weak mudstone roof and 11.3 m for a stronger sandstone roof.

If the source of mine methane is in the floor and cross-measure boreholes are to be used to control these emissions, it is necessary to evaluate the stress state within the floor of the longwall panel. Zhao et al. (2000) presented an analytical solution to determine the horizontal stresses in the floor of a longwall mining panel. The authors considered only the most important factors to develop an engineering model. In that study, empirical models that were used to analyze roof mechanical issues were extended and used to develop models for

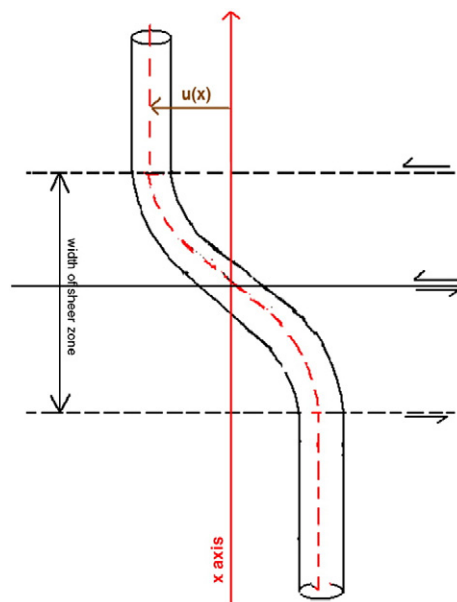

Fig. 15. Deformation of a steel casing of a vertical hole drilled into the immediate roof of a mine (Whittles et al., 2007).

floor mechanics. A number of parametric solutions using the proposed method to solve the horizontal stress problem were given. This method can also be used to evaluate the stability issues of cross-measure boreholes drilled into the floor of a longwall mine to control methane emissions.

4. Geological features and heterogeneities that affect gas emissions and removal from mines

Abnormal, unanticipated mine gas emissions in quantities sufficient to create hazardous conditions have often been attributed to various geologic features since the first recorded documentations of methane explosions in mines. For example, geologic features such as faults have long been recognized as conduits for gas flow from strata adjacent to mined coal beds. Other features such as sandstone paleochannels, clay veins, changes in permeability facies and coal types, and localized folding and shearing of the coal bed have also been widely recognized for their impacts on gas emissions into mine workings (Beamish and Crosdale, 1998; Diamond, 1982; Li, 2001; Li et al., 2003; Noack, 1998; Ulery, 2006).

It is not surprising that strata adjacent to mined coal beds can emit great quantities of methane gas into active mine workings. During the burial and diagenesis of the organic matter that ultimately forms mineable coal beds, similar dispersed organic matter in adjacent strata can produce methane in quantities far exceeding the storage capacity of the coal and surrounding rock. As a result, large quantities of methane can remain trapped in these strata. The flow of this gas at high rates into the mine workings may be either facilitated or temporarily impeded by the presence of geologic structures or anomalies during mining of the nearby coal seams. The emission events that are often distinctly associated with geologic features of varying scale are occasionally immediate and catastrophic; however, more often, these emissions are subtler and not easily detected without field reconnaissance and instrumentation.

The existence of various geologic anomalies and coal bed discontinuities, such as partings, faults, sand channels, and changes in coal bed properties, can create serious problems in the drilling, completion, and production of degasification boreholes. These geologic features can affect both the effectiveness of these boreholes for draining methane from the coal bed and for limiting methane emissions into the working sections by creating boundaries, high-

pressure gas and water pockets, and by changing flow characteristics of the reservoir. Thus, site-specific considerations are required for these challenging situations (Diamond, 1982).

In underground coal mines, the required amount of ventilation air is based on estimates of gas release under normal conditions. Occasionally, unanticipated and unusually high emissions are encountered. These emissions, despite normal ventilation controls, may result in an explosive mixture at the face that may be ignited during mining. Investigations have shown that such emissions can often be associated with anomalous geologic features or conditions. While most mine operators are aware that certain geologic features may adversely affect productivity, few are aware of their potential as a gas emission hazard (Ulery, 2006).

4.1. Effects of faults in coal bed on mining, mining gas emissions, and degasification efficiency

It is known that faults affect production characteristics of nearby coal bed methane boreholes. Faults can create boundaries for the drainage radii of the boreholes. These boundaries can be favorable or unfavorable in terms of gas production, depending on the size of the bounded reservoir. If the bounded volume is small, a limited amount of the reservoir will be drained and thus the production potential of such a reservoir will be low. If the borehole is drilled into a large but bounded reservoir, this will potentially lead to a faster pressure drawdown when dewatering is initiated, causing higher gas saturations and faster production rates.

The effects of faults on coalbed gas productions have been experienced in various regions. For instance, in the southeastern Deerlick Creek field (Alabama), fault blocks have variable production characteristics. Exceptionally productive wells drilled near the eastern margin of the Strip Mine graben have penetrated a fault and are actually completed in the Holt Lake half graben (Sparks et al., 1993). Although production within the half-grabens is variable, large-scale production patterns in the southeastern Deerlick Creek field indicate that normal faults can compartmentalize coalbed methane reservoirs.

Similarly, production patterns in the Cedar Cove field of Alabama (Sparks et al., 1993) indicate that being adjacent to a major fault system has enhanced gas and water production. Pashin and Groshong (1998) also reported major production experiences in complexly faulted regions in the coalbed methane fields of Alabama. Evidence suggests that faults in the Oak Grove field of the Black Warrior basin affect gas and water production as well as the thicknesses of the seams, especially in the up-thrown fault blocks. Patterns of gas and water production in the Deerlick Creek field provide evidence of structural segmentation of coalbed methane reservoirs by normal faulting. Exceptional production of both gas and water in parts of the Holt Lake and Franklin Hill half-grabens indicates local enhancement of permeability, and may also indicate a heterogeneous distribution of gas and water. Variable well performance in all parts of the field may be a product of engineering practice as well as interwell heterogeneity that is not discernible at the scale of the study. However, based on these observations and on others in Alabama's coalbed methane fields, Pashin and Groshong (1998) produced a conceptual model (Fig. 16) on structurally controlled coalbed methane production. The significance of these structures in terms of coalbed methane exploration and production has yet to be fully appreciated (Pashin and Groshong, 1998).

The tectonic events have had significant influence on the generation and preservation of the coalbed methane (CBM) in the Weibei Coalfield, China, as well. The Triassic–Cretaceous Orogenies may have had significant influences on the generation of coalbed methane, while the Tertiary Himalayan Orogeny may have had crucial effects on its retention (Yao et al., 2009). During the Triassic–Early Jurassic, compressional deformation led to formation of a series of thrusts and folds that significantly influenced the preservation of

methane in the Hancheng coal district where coalbed methane is concentrated in the axes and slopes of anticlines and fault zones. During the Yanshanian Orogeny (Jurassic–Cretaceous), compressional structures switched to a NW–SE orientation and had the most significant influence on the south margin of the Hancheng coal district. This event provided a good preservation environment for CBM and led to secondary gas generation and higher gas content (Yao et al., 2009). Thus, provided that reservoir properties of the coals are favorable, high methane productions and emissions in the mines in these regions can be expected.

Kedzior (2009) evaluated the methane accumulation in the Upper Silesian coal basin, Poland, and found that the Bzie–Czechowice fault, with a 200–600-m throw to the south, is an important tectonic element in the area. The study indicated that this fault and related fissures had probably always been pathways for upward gas migration. With the deposition of the Miocene clays, a methane reservoir began to develop on the up-throw side of the fault with methane contents relatively high ($>10 \text{ m}^3/\text{ton coal}$) near the fault in the Pniówek Mine. Measured methane contents in the Krzywzowice #28 and #30 boreholes on the up-throw side ($>6 \text{ m}^3/\text{ton coal}$) exceeded those in the Bzie–Dębina #20 borehole on the down-thrown side ($<4 \text{ m}^3/\text{ton coal}$). These data clearly show that the methane field is interrupted by the Bzie–Czechowice fault. The coal beds with the highest quantity methane are Carboniferous and are usually found near the up-thrown side of the fault, compared to the down-thrown side, which is less gas-rich. This shows that major faults can compartmentalize the coalbed methane reservoirs.

A related example was given Su et al. (2003). The authors discussed the conditions that led to the abnormal pressure regime of the Pennsylvanian age No. 8 coal seam in Liulin–Wupu District, Eastern Ordos basin, China. Based on their analyses, the authors suggested that the abnormally high pressures are associated with local hydrodynamic trapping and that this is where most productive coalbed methane wells are located. The authors further noted that there is a change both in pressure and in its gradient from east to west, where the southwestern part of the Anjianshan–Wupu area is under-pressured. This was attributed to the influence of the F1, F2, and F3 (F3 shown in Fig. 17) fault zones. In this area, every fault zone is composed of two normal faults that form a graben. The groundwater and the coal seam gas escaped along the fault zones, which lowered the gas content and hydrostatic head in the southwestern area. In other words, the basin was compartmentalized.

Faults are important for underground mining due to their pre-mentioned characteristics. Thus, effective mapping of faults in coal mining is critical for productivity and safety of the workers. This is especially true where the coal seams are impacted by large displacements (Keckojevic et al., 2005; Molinda and Ingram, 1989). For instance, underground room and pillar mines in the Coalsburg seam north and south of the Warfield fault in Mingo County, West Virginia, have been greatly impacted by the fault and related structures. Due to the combined effects of the folding and faulting, the northern mines are about 15 m (400 ft) higher in elevation than the southern ones. Overland conveyor belts connect mining blocks separated by the fault. The fault poses an extra challenge to mine development in this part of the Appalachian basin (Coolen, 2003). The location of faults is also important to mining of the Western Kentucky No. 4 seam, since much of the mining occurs along the Pennyrile fault system and many mines are bordered with faults. In this region, the mines are sometimes forced to ramp up and down to reach a relatively flat reserve (Greb et al., 2001).

Faults and the associated weakness zones may also be responsible for high gas concentrations encountered during mining (McCulloch et al., 1975). This is especially likely when there is stress redistribution as mining approaches a large-scale fault. In Germany, Thielemann et al. (2000, 2001) showed that in unmined regions, normal faults regularly act as gas conduits for surface emissions into the atmosphere

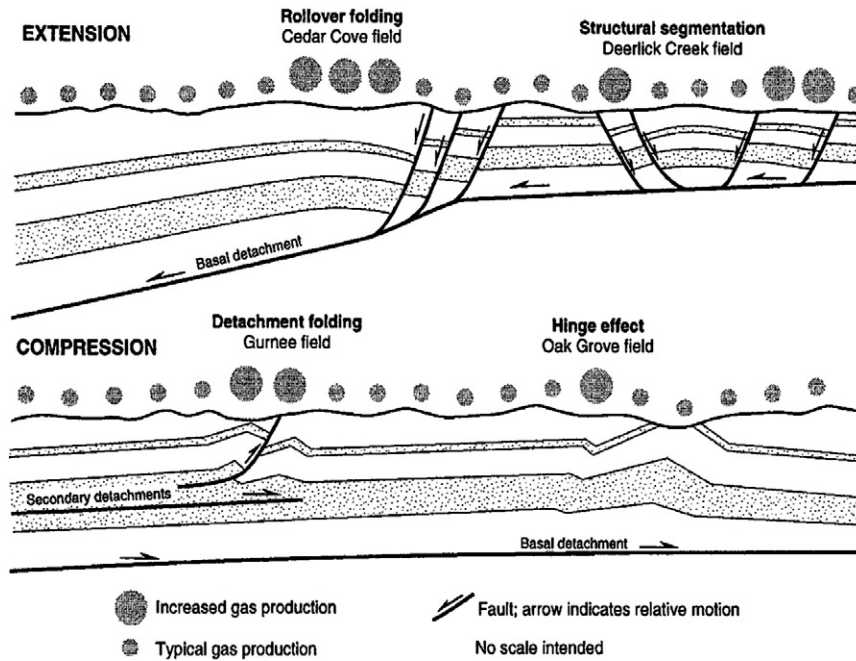

Fig. 16. Conceptual model of structurally controlled coalbed gas production in Alabama's coalbed methane fields. From Pashin and Groshong (1998).

from deep formations such as coal beds. The authors further demonstrated that distinctly higher rates of surface gas emission occurred from normal faults in mined areas. This was presumably caused by the increased permeability of the fault and associated strata in response to mining. Therefore, it would seem likely that such faults could easily become pathways for gas emissions into mine workings from adjacent source beds.

Alsaab et al. (2009) presented a study to estimate the production of methane, to define its migration paths and storage in formations, and to forecast mining hazards in the Donets basin (Donbass), Ukraine. The authors indicated that in the Donets–Makeevka area,

where specific methane emissions are $\sim 60 \text{ m}^3/\text{ton}$, gas migrated along faults, and gas accumulations were mostly close to structural deformations and in the hanging walls of reversed faults. Gas also migrated and accumulated along W–E extending faults in the region. From a mining safety and CMM recovery point of view, the outburst-prone coals are found in coal mines where specific gas emissions are high. The zone with 60 m^3 methane/ton of mined coal corresponds to the Zasyadko coal mine that is located close to Donetsk city, which is close to the Donets–Kadiievka fault. This coal mine was reported as very dangerous because of coal and gas outbursts. It was further observed that (Fig. 18) the outbursts (circles) are located all alongside

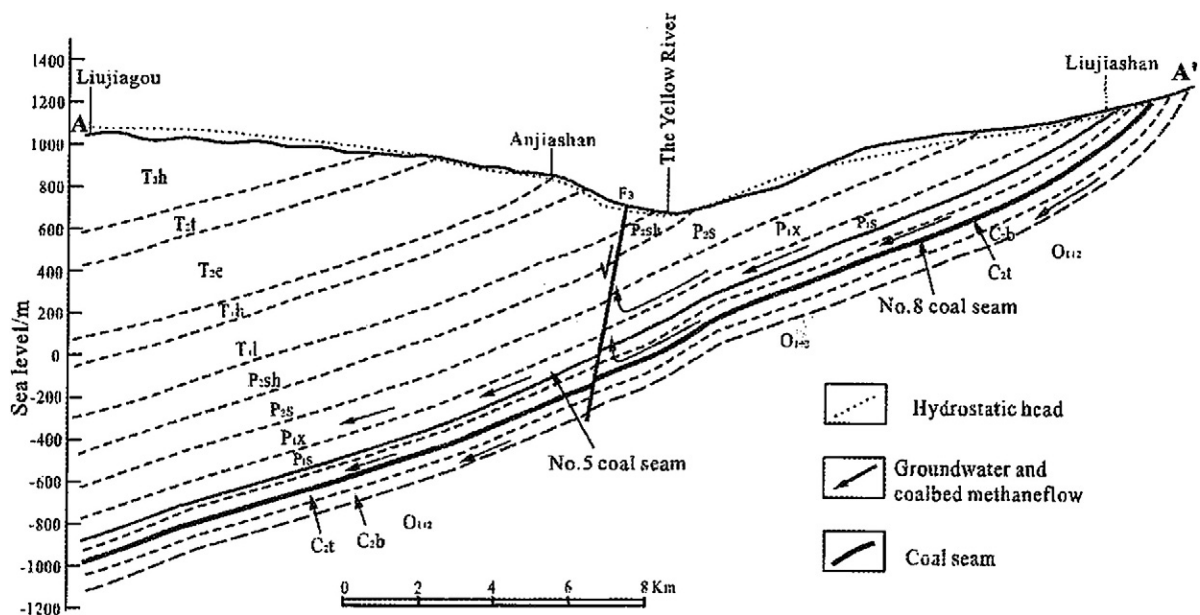

Fig. 17. A hydro-geological profile in Liulin–Wupu District, Eastern Ordos basin. From Su et al. (2003).

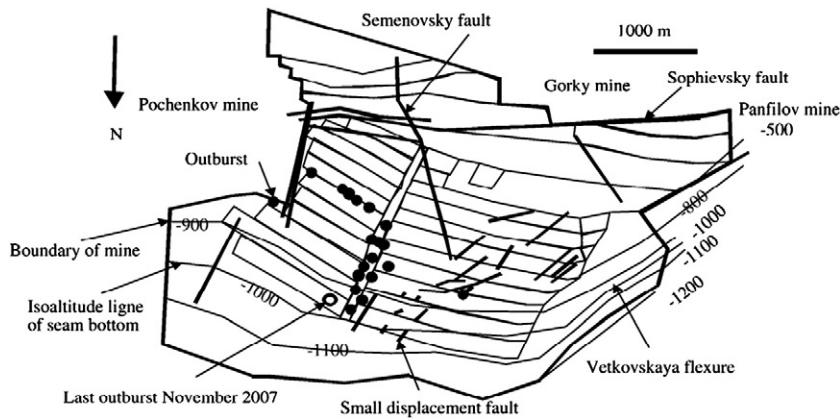

Fig. 18. Structural and mine map of the coal seam in the Zasyadko coal mine. From Alsaab et al. (2009).

of a particular panel of the mine and located in the vicinity of small-displacement faults and knee-shaped folds. Small-displacement faults which caused dramatic obstacles for safe and efficient underground coal mining have been traditionally interpreted in the Donbass as being normal and/or reversed faults with a vertical or stratigraphic displacement of less than a few meters.

Shepherd et al. (1981) integrated various aspects of stresses, gas, and geological structure in a worldwide review of outbursts of coal and gas in coal mines. The authors identified geological structures as a prime factor in outburst occurrence. They noted that thrusts, strike-slip faults, and recumbent fold hinges are especially outburst-prone and concluded that anomalous stress and gas conditions exist in and close to geological structures. At such sites, mining-induced fracture systems, microseismic noise, and abnormally high gas emissions have been recorded. Cao et al. (2001) investigated four coal mines in the Pingdingshan coal field, Henan Province, China. The authors reported that coal and gas outbursts associated with reverse faults (Fig. 19) almost always occurred in the footwalls of the reverse faults which underwent greater tectonic deformation than those in the hanging walls. In those areas, coal lost its banded character and was physically

transformed into microstructurally altered forms categorized as cataclastic coal, granular coal, and mylonitic coal. They reported that outbursts always occurred within a zone of this tectonically altered coal surrounding the fault. Therefore, the identification of fault and methane-pressure buildup zones may be the key for effectively draining the coal gas ahead of mining to reduce gas pressure and to control outbursts.

As demonstrated in the previous discussions, geologic faults in a coal seam can cause intermittent production problems or can cause unexpected amounts of water or gas to issue from degasification boreholes. These faults also can impact methane emissions into the mine workings, especially if they hinder proper and effective degasification of the coal bed. Faulting may also cause gas pressure buildups and result in compartmentalization of the gassy regions, from which large quantities of water and methane may rush into the mine workings. In order to investigate the effects of impermeable faults on the production performance of vertical and horizontal degasification boreholes, and on methane emissions into an advancing longwall, Karacan et al. (2008) conducted a reservoir-simulation-based study.

Fig. 20 gives a cut-away view of the reservoir simulation grid for the case of a down-thrown block (A) as well as the effects of the proximity of the fault to a vertical borehole on water and gas encroachment into the approaching longwall (B). The general conclusions of this simulation study indicated that the methane production of a horizontal borehole was not significantly affected by the presence or displacement direction of a fault located 343 m distant. This was not the case with a vertical borehole, which after 175 days of operation showed increased methane production compared to the base model. This increased methane production likely arose from the pressure transients from the vertical borehole reaching the impermeable fault boundary and causing increased production from the wellbore-side block. Further simulations showed that an impermeable fault in close proximity to the vertical borehole had greater impact on its production. A fault located farther from this borehole had much less impact.

The location of a vertical borehole limits the methane emissions into a mine in a faulted coal seam. Simulations were conducted of methane and water inflows in the presence of a fault located 343 m distant from a longwall face (Karacan et al., 2008). The results showed dramatic reductions in gas and water inflows once the face passed through the fault into the borehole block. These data suggest that mining into the borehole block is preferable to mining in the other direction, which would lead to dramatic increases in methane and water inflows. Similar results were found when the impermeable fault was located 114 m and 572 m distant from a vertical borehole. Methane emissions and water inflows again decreased once the face

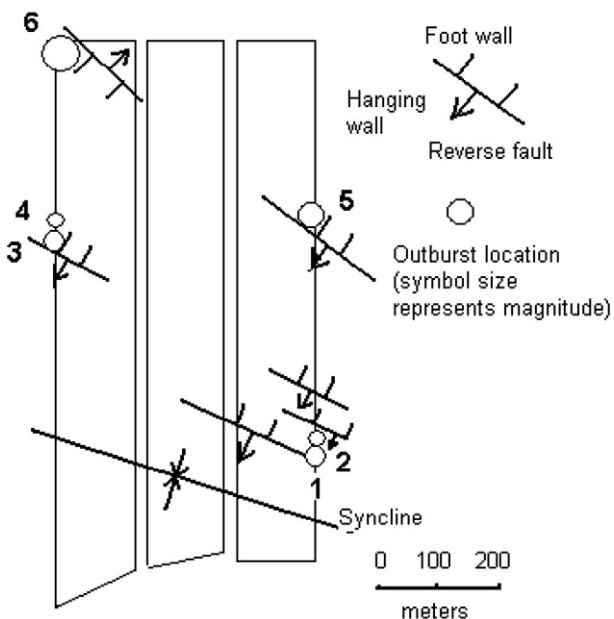

Fig. 19. Outbursts in the footwalls of reverse faults in the No. 12 coal mine of Pingdingshan Coal Administration. Modified from Cao et al. (2001).

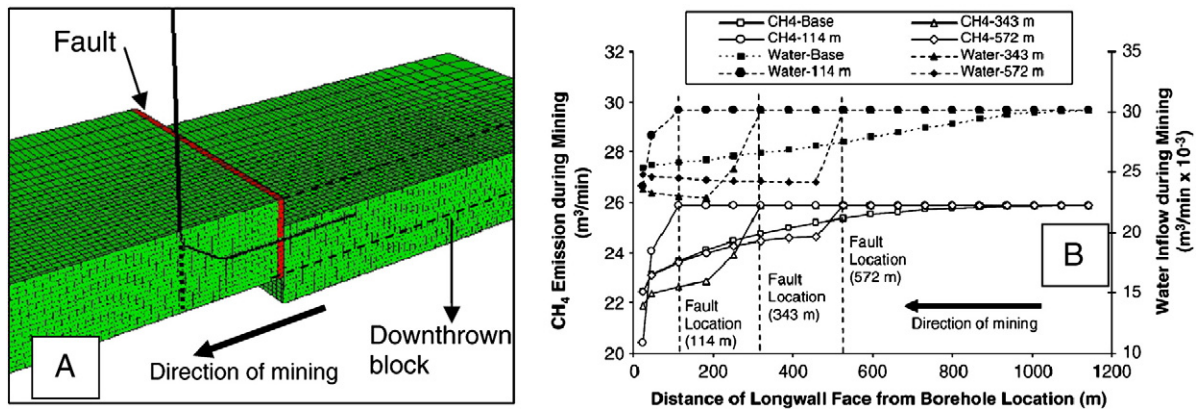

Fig. 20. A cut-away of the reservoir simulation grid for the case where a down-thrown block is shown (A) as well as the effect of the proximity of the fault to vertical borehole on water and gas encroachment into the approaching longwall (B).

passed through the fault. Average reservoir pressures also decreased at this point.

Ulery (2006) provided some borehole designs to drain potential gas emission sources associated with normal and reverse faults. These options are given in Fig. 21 for various types of faults and directions from which the mine entry approaches. The author also indicated that if the faults and their possible throws were not mapped accurately, both vertical and horizontal boreholes may miss a portion of the coal seam for degasification and this may result in inaccurate estimations of expected gas emissions into the mine.

4.2. Effects of partings in the coal seam for coal mine methane emissions and degasification

Coal beds can include various non-coal materials deposited during peat accumulation. Such non-coal material may be referred to as partings in the coal bed. These non-organic material-rich horizons are

composed of mineral matter that is commonly argillaceous (clay), siliciclastic (quartz-dominated), and occasionally includes carbonate rocks. Most are the result of changes in the depositional environment within the peat swamp in which the coal was forming. A special form of parting is composed of altered volcanic ash layers (tornstein) which represent volcanic events of short duration and therefore are nearly isochronous horizons, such as in the Ferron group in Utah, which may also be found within coal seams (Lamarre, 2003). Rock partings or parting layers create density variations in the coal, which are a function of mineral material, or ash, within the coal seam (Beaton et al., 2006; Manchioni, 2003). Most importantly in relation to fluid and gas flow, these partings create strong discontinuities in the petrophysical fabric (porosity and permeability) within the coalbed methane reservoir.

During coal seam degasification, boreholes drilled in an area of extensive partings could encounter irregular flows of gas. A horizontal borehole drilled completely above or below an extensive parting, or a

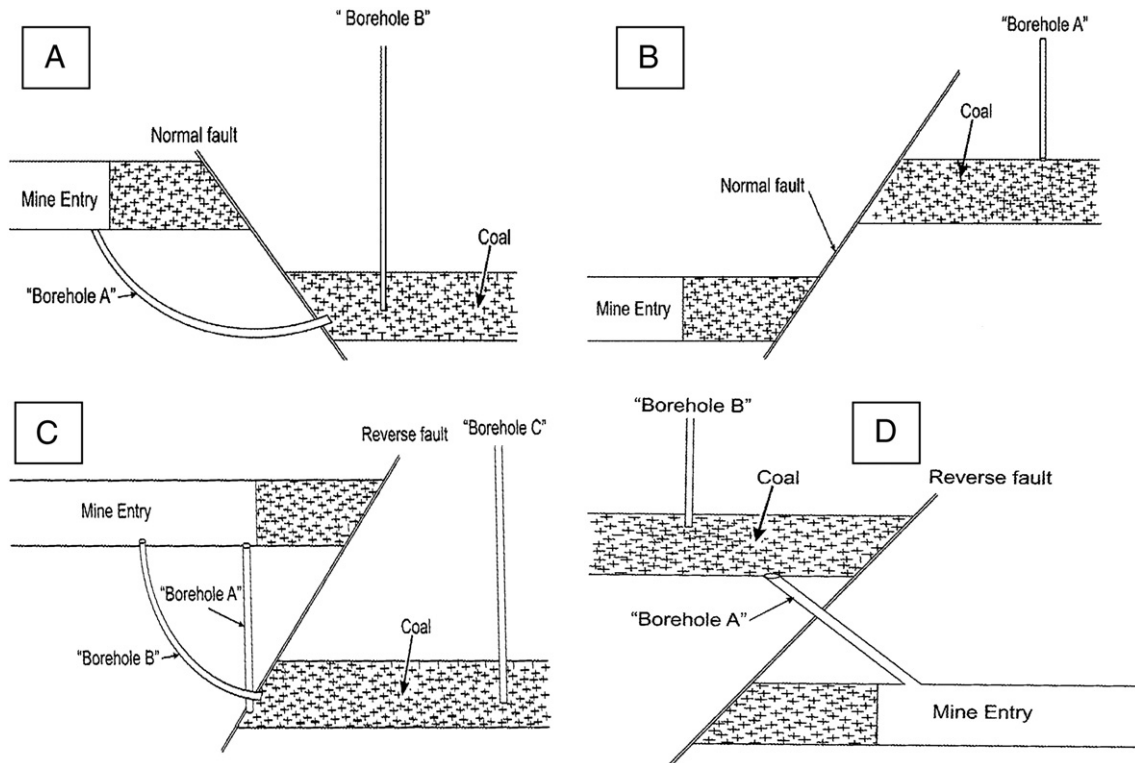

Fig. 21. Methane drainage of a normal fault from “footwall” (A) and hanging wall (B) sides. Methane drainage of a reverse fault from the “hanging” wall (C) and “footwall” sides (D). From Ulery (2006).

collection of partings that effectively separates a coal bed into separate reservoirs, may drain methane only from that portion of the coal bed. The rest of the coal bed would remain undrained and the gas still would represent a potential hazard to the future mining activity or would be unavailable for commercial production (Diamond, 1982). In the case of vertical boreholes, encountering partings can also be problematic to the flow of gas. Since the length of a vertical borehole is much less than a horizontal borehole, drilling into a thick parting interval may render the borehole useless.

Extensive parting layers can create problems in stimulating wells, too. If the fracturing treatment does not penetrate effectively above and below the parting, the flow could be reduced. Parting layers that compartmentalize the coal bed hydraulically are also important from a mine ventilation standpoint since they can isolate large volumes of gas that can suddenly be liberated when penetrated by a mine entry.

4.3. Effects of permeability facies and spatial changes in coal types and coal microlithotypes on emissions into mines

One of the common features of coal beds is variation of coal types. These variations manifest themselves as changes in petrographic characteristics of the coal on various scales, from megascopically recognizable units – lithotypes to microlithotypes and macerals – to changes in geomechanical properties of the coal seam. The origin of coal type variations can be due to groundwater level fluctuations in the ancient peat-forming environments, different peat accumulation rates (Silva et al. 2008, or changes in the type of primary vegetation that contributed to the peat (Calder, 1993; Diessel et al., 2000; Moore, 1989). From duller to the brighter lithotypes, there is a significant decrease of inertinite contents and an increase in vitrinite. Local variations in inertinite contents can be linked to an incomplete burning of the organic matter by local fires or aerobic biodegradation due to bacterial attack when the water level dropped (Silva et al., 2008).

It has been previously recognized and documented that different coal components have varying gas generation and storage capacities (Beaton et al., 2006; Gurdal and Yalcin, 2000; Karacan and Mitchell, 2003; Lamberson and Bustin, 1993. Most researchers agree that vitrinite-rich, bright coals have a greater methane adsorption capacity than inertinite-rich, rank-equivalent coals. However, in some cases, inertinite-rich coals have been found to have the greatest methane adsorption capacity (Clarkson and Bustin, 1996; Karacan, 2007a,b; Mastalerz et al., 2004) mostly due to the volume created by the fusinites with open-cell lumina. An example scanning electron microscope (SEM) image of fusinites and phytal porosity filled with clay minerals is shown in Fig. 22.

Different coal types also have different desorption rates, which can impact gas emissions and borehole productions. Studies on coal samples have shown that dull coals desorb more rapidly than bright coals (Karacan and Mitchell, 2003; Karacan and Okandan, 2001). Both rank and coal type were found to influence effective diffusivity. Dull coals have faster desorption rates (2–3 times) than their bright equivalents in most cases (Laxminarayana and Crosdale, 1999) due to a predominance of large, open-cell lumina (Crosdale et al., 1998; Karacan and Mitchell, 2003; Karacan and Okandan, 2001). Bright, vitrinite rich coals usually have the slowest desorption rates, which is associated with their highly microporous structure. Therefore, a horizontal borehole trajectory that follows the dull layers may have a better chance of producing higher gas rates.

The importance of different coal lithotypes and microlithotypes in underground coal mining has been summarized in previous studies. For instance, variable gas desorption rates for different coal types were reasoned to impact outbursts in mines (Beamish and Crosdale, 1998). As pressure is removed from the coal in the mine-face environment, different desorption rates of the coal lithotypes create a large gas content gradient, as follows: (1) vitrinite-rich or inertodetrinite-

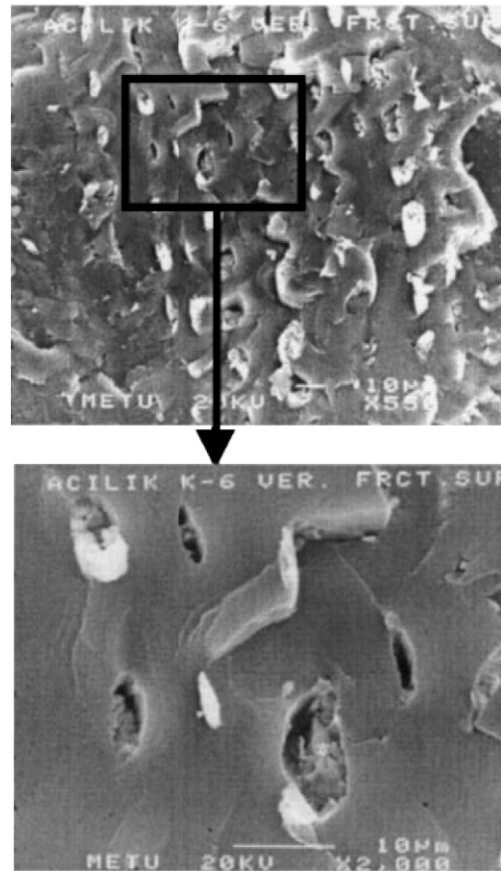

Fig. 22. SEM image of fusinite in Acilik coal (Zonguldak Basin, Turkey) with phytal porosity partially filled with clay minerals. Modified from Karacan and Okandan (2001).

rich coal bands do not desorb rapidly, retaining their gas and thus producing a steep gas content gradient and (2) fusinite-rich or semi-fusinite-rich coal bands lose their gas more rapidly and thus have a shallow gas content gradient. In addition, when the coal strength information is combined with the sorption behavior of coal macerals, it is suggested that the outburst-proneness of coals rich in vitrinite and inertodetrinite is greatly increased (Beamish and Crosdale, 1998). Overviews of coal-gas outbursts are also given in Flores (1998), in Beamish and Crosdale (1998), in Noack (1998) and in Shepherd et al. (1981).

Permeability is a critical factor controlling methane and water production from coal seam reservoirs and for determining the efficiency of a degasification project. However, reservoir permeability usually is not constant and not uniform throughout the reservoir. Coal cleats, their spacing, and their permeability are known factors creating preferential flow direction and magnitude in the coal seam. Coal deformation is another factor affecting coal permeability. For instance, in the Qinshui Basin of China, the coal seam is severely deformed and contains mylonitic structures where the primary permeability is obstructed. Thus, permeability of the coalbed methane reservoir is controlled by shear fractures, creating significant reservoir heterogeneity and making it difficult to describe a permeability distribution (S. Su et al., 2005; X. Su et al., 2005) for degasification studies.

Generally, high permeability areas in the coal bed are more productive and better suited for methane production compared to low permeability zones. For example, the highly productive “fairway zone” of the Fruitland formation in the San Juan Basin of Colorado and New Mexico contains individual wells that can produce 28–170 × 10³ m³/day (1–6 MMscf/day). Permeability within the San Juan

Basin ranges from 15 to 60 mD in the high productive fairway zones and tapers to less than 5 mD in the least productive areas of the basin (Ayers, 2002). This and similar studies suggest that the highest permeability coals have the best reservoir characteristics. However, Bustin and Clarkson (1998) showed that such reservoirs consequently may have the lowest gas saturation due to leakage and thus may have poorer coalbed methane resource potential. On the other hand, if the coal seam is non-permeable, it may have a higher gas content which may be released only during the crushing process as mining progresses. This condition may lead to lower gas production potentials during degasification, but higher methane emissions that may create an unsafe atmosphere during mining.

In the Black Warrior basin, a strong structural control is present on gas and water production, and the relationship of production to structure is different in each field analyzed. Variable well performance in all areas suggests that hidden inter-well heterogeneity related to fractures, high permeability pathways, and shear structures influences production (Pashin, 1998). Thus, the regional permeability and the gas content generalities cannot be applied uniformly across the basin or to each coal seam.

5. Methane emission and recovery from abandoned underground coal mines

Following mining activities, coal mines are typically sealed and abandoned either temporarily or permanently. To prevent methane buildup and gas migration to the surface through overburden fractures, some underground abandoned mines may continue to be vented to the atmosphere through wells, portals, and shafts. As work stops within the mines, the methane liberation decreases but it does not stop completely. Following an initial decline, abandoned mines can liberate methane at a near-steady rate over an extended period of time or, if flooded, for only a few years.

Unintentional venting of methane can also occur through the conduits described above, particularly if they have not been sealed adequately. In addition, diffuse emissions can occur when methane migrates to the surface through cracks and fissures in the strata overlying the coal mine. The following factors influence abandoned mine emissions:

- time since abandonment;
- gas content and adsorption characteristics of coal;
- methane flow capacity of the mine;
- mine flooding;
- presence of vent holes; and
- mine seals.

Water encroachment into the abandoned mines is common if the mines are connected to the local hydro-geologic system by faults or if the extracted coal seam was part of the system. Continuous water flooding into abandoned mines is important if it rebounds to the natural levels and reaches the surface. These discharges from abandoned mines are characterized by high sulfate and iron with low alkalinity as a result of oxidation of pyrite. The ferrous iron often subsequently oxidizes and hydrolyzes, precipitating “orche” that can smother stream beds and can devastate the quality and ecology of surface waters (Banks and Banks, 2001). Discharges from abandoned mines from an extensive network of abandoned underground coal mines in the Uniontown Syncline, Fayette County, PA, showed that water quality can improve over time (Lambert et al., 2004). The degree and rate of water quality improvement was found to be highly dependent on the amount and duration of flooding in the mine voids. Water quality of discharges from the substantially flooded mine voids (roadways, gob, room-and-pillar sections) improved significantly, going from acidic water with high sulfate and iron concentrations to alkaline water with substantially lower sulfate and iron concentra-

tions. In contrast, the water quality in the unflooded mines showed less improvement.

Water quality and management of discharges from abandoned mines is an important consideration, but it is beyond the scope of this paper. Therefore, this discussion will simply note that abandoned mines can be completely and partially flooded over time, which is important from a gas management and capture point of view, since flooding can inhibit gas emissions and buildups in the void spaces.

The rate and amount of methane buildup is usually proportional to how much coal is left in these areas, the coal's gas contents and reservoir properties, the amount of mine void that is not flooded, and the existence of other gas sources within the gas emission zone of the abandoned area. Gas accumulation and pressure buildup within abandoned mines can be potentially dangerous for active mines, if they are nearby, by overloading the ventilation system as a result of gas inflows into working areas during periods of decreasing atmospheric pressure. Abandoned mines can also present a danger to active mines operating at a greater depth if the abandoned mine happens to be within the fracture zone, so that any methane accumulation can migrate downwards into the active mine to create a sudden methane emission into the ventilation system. Therefore, abandoned mines sometimes are left venting to prevent gas accumulation.

Instead of releasing methane emissions from abandoned mines to the atmosphere, recovery and utilization should be considered. This will both reduce the possibility of methane emissions into underlying or nearby operating mines and limit the greenhouse effect. However, if the abandoned mine is close to the operating mines, drilling production boreholes and setting operating pressures should be done with full knowledge of the location and condition of the seals and the mine voids.

5.1. Detecting mine voids

Detection of mine voids to produce gas from abandoned workings has usually relied on existing maps and exploration boreholes. However, maps may not be updated and thus may not show the existing boundaries of abandoned workings. In addition, the extent of pillars and old workings can change due to underground stress conditions. Therefore, the maps that show the conditions at abandonment may not give the most accurate information on the latest conditions. A similar argument may apply to exploration boreholes for voids: they may not be fully informative on the conditions and sizes of voids, while the characterization of regions between boreholes remains unknown. Therefore, geophysical measurements can be used to augment the borehole data, improve the knowledge of intermediate zones between exploration boreholes, and better identify the voids in abandoned workings. Furthermore, geophysical techniques can be used to optimize the number and locations of the producing boreholes and their proximities to abandoned mine seals and active mines.

There are several surface geophysical methods that are applicable to detect subsurface voids such as gravimetric, seismic measurements, electromagnetic methods, magnetic, and ground penetrating radar. The operational principles of these methods will not be covered here; however, it has been demonstrated that commercially available technology can effectively detect and delineate mine abandoned mine workings (Johnson et al., 2002). Two techniques in particular have shown the greatest potential for application. The DC resistivity method offers the best potential for the rapid mapping of mine workings at a depth of 40 m or less. For workings at depths of 40 m or greater, the seismic reflection method, especially with the use of S-waves, has the greatest potential for success.

Johnson et al. (2002) have demonstrated the use of various S-wave profiles over abandoned coal mines to detect mine openings that would be suitable targets for the installation of methane extraction wells and to evaluate the conditions of these old workings. During the

trials to detect voids in these studies, boreholes were also drilled on the basis of old mine maps. However, some of the boreholes did not encounter the mine voids. S-wave surveys were performed in lieu of conventional P-wave surveys to detect the mine voids, because S-waves would not transmit through a void. It was demonstrated that S-wave seismic surveys can be used successfully to locate mine openings. Fig. 23 gives an example of detecting mine voids using reflection amplitude for a mine in Danville, Illinois.

5.2. Methane emissions evaluation

The U.S. Environmental Protection Agency (U.S. EPA, 2004) has documented probably one of the most comprehensive and detailed inventories of abandoned mines in the U.S. and developed a methodology to evaluate their methane emissions potential in relation to producing this gas. This study classified the abandoned mines into three general categories – sealed mines, flooding mines, and venting mines – and proposed an evaluation strategy for each. Fig. 24 shows U.S. EPA (2004) methodology for calculating abandoned mine emissions.

As has been demonstrated in the previous sections of this review paper, CMM generation and emission in active mines can be functions of various coal- and mining-related parameters. However, in abandoned mines, mining-related parameters can be canceled out and methane emissions can be thought of and evaluated only in terms of coal gas content and pressure at abandonment, the void space, gas emissions space left from the mining disturbances, permeability of the methane source into the mine voids, and the boundary conditions of the mine (i.e. whether it is being vented, tightly sealed, or being flooded as a function of time). Therefore, an abandoned mine can be characterized as a well experiencing rate transient (decline), and decline curve techniques can be used to evaluate gas emission potential and duration.

In traditional decline curve techniques, constant or time-dependent decline rates can be analyzed using exponential, hyperbolic, or harmonic decline functions. The U.S. EPA (2004) method also uses these techniques and proposes that a hyperbolic decline function can closely characterize the measured methane emissions rate from abandoned mines as a function of time. By fitting field data to a hyperbolic equation, the decline coefficients can be determined for a particular mine, in a specific basin, and with different mine conditions corresponding to flooding and venting cases. From these data, future emission potentials can be forecasted and engineering planning and economic analyses can be made.

Using traditional decline curves for evaluating emission potential of abandoned mines can be acceptable for abandoned mines evaluation, although traditional decline curves are mostly used for non-coal reservoirs in oil and gas engineering. But more importantly, they are

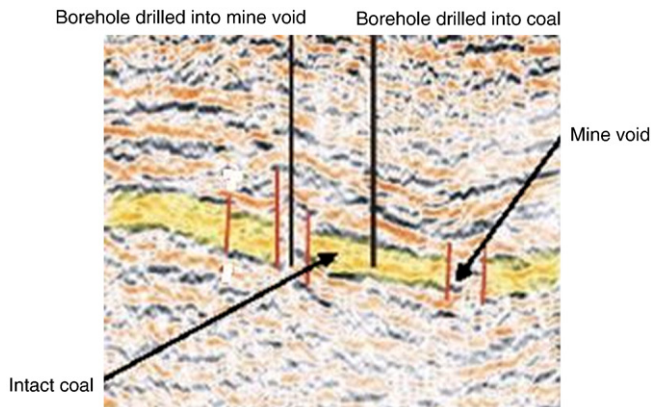

Fig. 23. Intact coal and mine voids detected using S-waves in a mine in Danville, Illinois. Modified from Johnson et al. (2002).

formulated to be used only for the boundary-dominated flow regime of a wellbore, neglecting any transient portion. Therefore, it may be a better and a more informative approach to use the Fetkovich type curves (Dake, 1978), which have both traditional empirical decline curve stems (exponential, hyperbolic, and harmonic) for the boundary-dominated region, and a transient portion for the theoretical constant pressure solution to the diffusivity equation. This approach covers both flow regimes while evaluating the emission potential of an abandoned mine.

An example of Fetkovich-type curve with fitted data of a GGV is given in Fig. 25. In this figure, different solutions in boundary-dominated and in transient-flow portions are represented with different colors to match the field data. In the boundary-dominated part, curves with different colors represent the decline coefficients. For instance, the red curve is “0” and indicates exponential decline, whereas the green curve in the middle is “0.5” and indicates hyperbolic decline. The transient portion is composed of theoretical constant pressure solutions to the diffusivity equation for different dimensionless external radii that are shown with different colors. In this set of solutions, the dark blue is $r_{eD} = 10,000$, and the red is $r_{eD} = 10$. Other colors correspond to different dimensionless radii values. This information can be used to calculate permeability, skin, original gas in place, expected ultimate recovery (EUR), and time to abandonment.

Numerical reservoir simulation techniques can also be used to model the abandoned mines and to predict their emissions and methane production on a regional scale. However, as noted earlier, the difficulty associated with this technique is that it requires an extensive amount of data, some of which is impossible to obtain. Therefore, numerical modeling techniques are adequate for sensitivity studies to evaluate how various project parameters may change the forecasts. Nevertheless, Collings (2003) used reservoir simulation of a hypothetical mine to build simple models to show productivity of boreholes drilled in an abandoned mine property and the longevity of production in the face of flooding. The author also noted that such models could help to develop resource areas and to evaluate the effects of uncertainties in key parameters. Durucan et al. (2004), on the other hand, applied reservoir simulation to model methane recovery from an abandoned mine at the Saar Coalfield, Germany. The authors used historical data on mining and methane emissions, as well as long-term methane production monitored from the Hangard shaft, to validate model development. As a result of the modeling, high-methane partial-pressure zones in the region were identified as potential sites to drill boreholes to produce high-purity methane and to avoid air contamination. These studies show the use of numerical reservoir simulation for identifying the methane production potentials from abandoned mines.

Surface coal mines also release methane as the overburden is removed and the coal is exposed, but the level of emissions is much lower than from underground mines. This primary reason for this is due to the relatively low gas content of the coals that are mined from the surface. The low gas content of these coal seams is likely related to the shallow depth of burial and the fact that some are lower rank with commensurately lower gas adsorption capacity. In addition, lower gas content in the coals mined from surface mines may be that the gas that was generated from these shallow coals migrated up and escaped to atmosphere long before the mining activity began. Finally, some of the methane retained in the coal after it leaves the mine is released through desorption during processing, storage, and transport of the coal.

Coal mine methane that is successfully assessed and captured by various techniques before, during, and after mining operations, or from abandoned mines, can ensure the safety of an underground coal mine. This gas can also be used as an energy source, thereby reducing the greenhouse effects of methane. The rest of this paper is dedicated to a review of how energy can be harnessed from CMM, thus reducing its greenhouse effect with different applications.

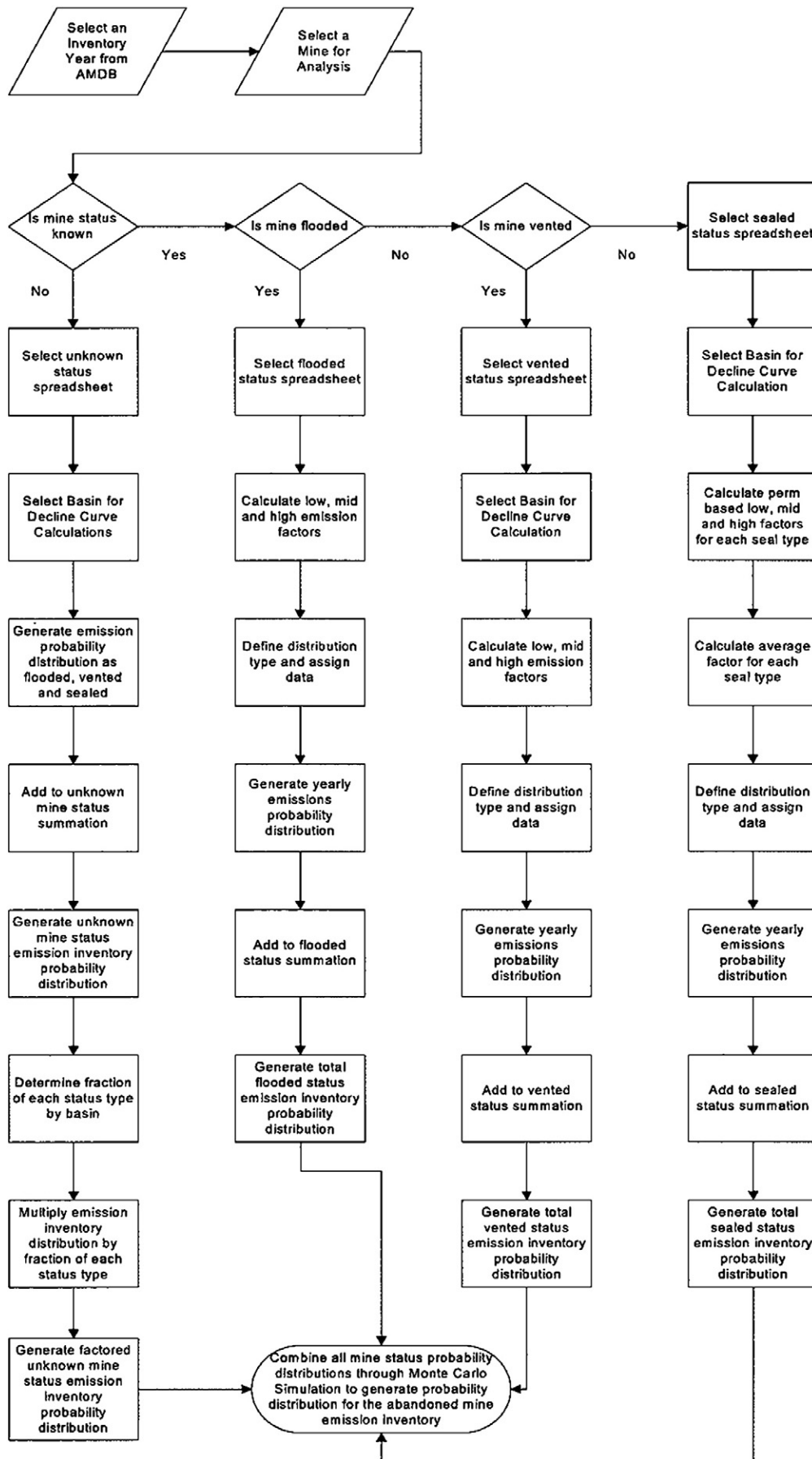

Fig. 24. U.S. EPA (2004) methodology for calculating abandoned mine emissions.

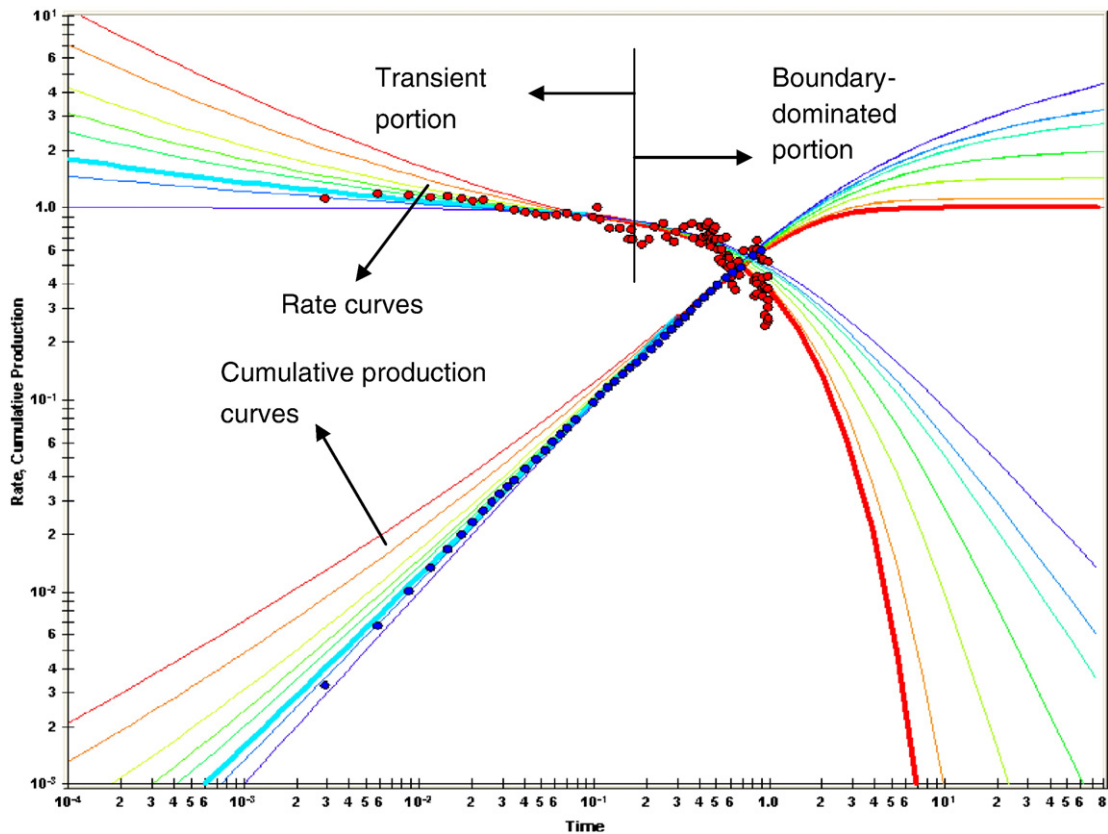

Fig. 25. An example of Fetkovich type curves with fitted data of gob gas venthole production during mining and after the panel was sealed. The unit of time in this plot is “days,” and the unit of production rates and cumulative amounts are m^3/day and m^3 , respectively. The field data in this analysis are matched to exponential decline and $t_{eD} = 1000$ for further processing.

6. World coal mine methane (CMM) overview

CMM is released from coal mines throughout the world, and often the largest emitters are countries with the highest production of high-rank underground coal. Currently, the top two producers of coal and emitters of CMM are China followed by the United States (U.S.). Other large coal producers include Russia, Australia, the Ukraine, and India. Over the past ten years, CMM emissions have been gaining greater attention due to their status as a greenhouse gas (GHG) and their potential use as a clean energy resource. As a result, many countries have begun to perform periodic inventories of their CMM emissions.

Countries that are Parties to the United Nations Framework Convention on Climate Change (UNFCCC) are committed to reporting their national greenhouse gas inventories to the Secretariat of the Convention. Developed (or Annex I) countries such as Australia, Russia, the Ukraine, and the U.S. have reported their stand-alone inventories on an annual basis, which are then peer-reviewed by technical experts. These inventories are posted on the UNFCCC Web site. Developing (or Non-Annex I) countries such as China and India report their national greenhouse gas inventories on a less frequent basis as part of a broader national report called a “national communication.”

The U.S. EPA has worked with the reported UNFCCC data and has developed historical estimates and projected estimates (1990–2020) of the global GHG emissions and sinks for a multitude of emission sources. The total 2005 global anthropogenic CMM emissions were estimated to be 432.3 million metric tons of CO_2e (MtCO_2e). According to the U.S. EPA equivalency calculator, the 2005 global CMM emissions are equivalent to the total annual GHG emissions (CO_2e) of approximately 77.2 million passenger cars. The percent contribution for each country’s estimated 2005 CMM emissions are illustrated in Fig. 26.

The global trend in estimated CMM emissions from 1990 to 2020 is illustrated in Fig. 27. Between 1990 and 2000, CMM emissions

decreased by approximately 27.1%. The drop in global emissions is associated with a decline in coal production in many countries, in addition to a restructuring of the coal industries in countries such as China, Russia, and other Eastern European coal-producing countries (U.S. EPA, 2006). From 2000, the global CMM emissions are projected to rise by approximately 27.3% or greater. The expected overall decline is attributed to underground coal mining production shifting to less gassy surface mining (e.g. the Powder River basin in the U.S.) and CMM emissions reductions due to an increase in methane recovery and use projects (U.S. EPA, 2006).

6.1. China

China is the world’s top producer and consumer of coal and coal accounts for approximately 70.0% of the country’s total national energy consumption (Cheng et al., 2011). In 2008, China produced 2.58 billion metric tons of coal and consumed 2.57 billion metric tons of coal (U.S. EIA, 2008). Following reorganization in 2009, current estimates indicate that China has close to 15,000 mines, of which 268 are state-owned mines producing approximately one-third of China’s coal. Nearly 90% of the county’s coal production is from underground mining (U.S. EPA, 2009a) and approximately 85–95% of total CMM emissions come from underground mines where ventilation air methane (VAM) is the largest contributor (Cheng et al., 2011).

The State Administration of Coal Mine Safety of China labeled 15,071 coal mines in 2007, and 12,722 in 2008, in 26 provinces/autonomous regions/municipalities, as “gassy” mines. It is estimated that China’s total emitted CMM was 19.3 billion cubic meters (289.8 Tg CO_2e or 289.8 Tg of carbon dioxide equivalent) and 20.2 billion cubic meters (304.5 Tg CO_2e) in 2007 and 2008, respectively (Cheng et al., 2011). The Methane to Markets International (M2M) CMM Projects Database currently identifies 82 active or proposed CMM projects

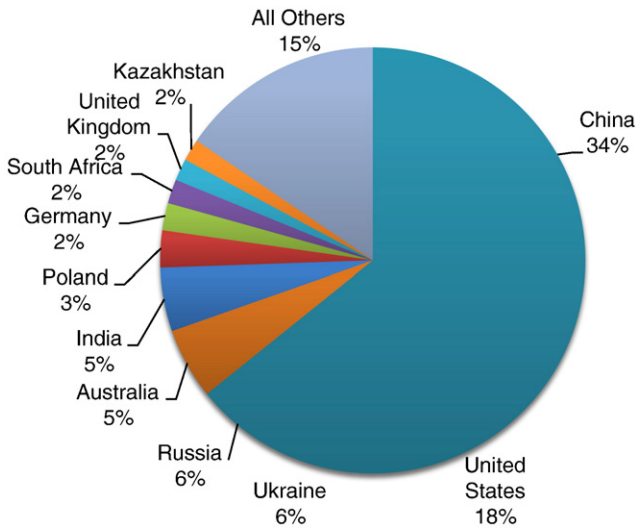

Fig. 26. 2005 estimated global CMM emissions (MtCO₂e) (U.S. EPA, 2006).

and one closed project in China. All but two are confirmed in active underground mines. Table 5, in the “CMM capture and utilization projects” section of this paper, lists the number of projects by type and current operating status.

The closing of state-owned coal mines and town and village coal mines that do not meet production and safety requirements leaves many mines abandoned, potentially emitting large amounts of abandoned mine methane (AMM). To date, China has not inventoried its AMM emissions, and no AMM-related projects have been initiated in China so far.

6.2. United States

The United States is the second largest producer and consumer of coal worldwide and is also the second largest emitter of CMM. Coal accounted for 32.5% and 29.6% of the total energy production of the U.S. in 2008 and 2009, respectively (U.S. EIA, 2009b). The U.S. exported 6.96% of its coal production in 2008 and 5.5% in 2009, while its imports equaled 2.9% of its total domestic production in 2008 and 2.1% in 2009 (U.S. EIA, 2009a). Although the U.S. coal mining industry is privatized, the U.S. EPA has conducted annual inventories of CMM emissions from active and abandoned mines since 1990.

In 2009, 14 out of 135 gassy active underground coal mines collected methane from degasification systems and utilized this gas, thus reducing approximately 16.2 Tg CO₂e emissions to the atmosphere. Of these mines, 12 coal mines sold methane to natural gas pipelines and one coal mine used methane from its degasification system to heat mine ventilation air on-site. In addition, one of the coal mines that sold gas to pipelines also used methane to fuel a thermal coal dryer. The total 2009 CMM emissions (including AMM) are

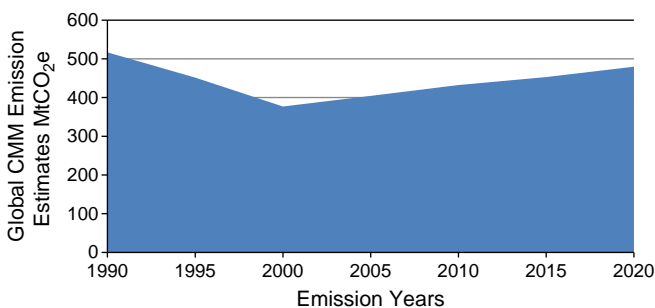

Fig. 27. Estimated global trends in CMM emissions (U.S. EPA, 2006).

estimated to be 5.5 billion cubic meters of methane (U.S. EPA, 2009b). Of this amount, underground mines accounted for 70%, surface mines 14%, abandoned mines 8%, and post-mining emissions 8%. Fig. 28 depicts U.S. CMM emissions by source category.

The majority of the methane from abandoned mines in the U.S. is vented to the atmosphere, and only 38 abandoned underground mines recover methane (U.S. EPA, 2009c). According to the U.S. EPA AMM Inventory in 2009, there were 469 abandoned gassy underground mines. It is estimated that the 469 abandoned gassy mines emitted 8.1 Tg of CO₂e, of which 3.0 Tg of CO₂e was recovered. After recovery and use, the total 2009 U.S. AMM emissions are approximately 5.1 Tg of CO₂e (U.S. EPA, 2009c).

The U.S. EPA currently identifies 39 operating or planned CMM and AMM projects and one closed CMM project in the U.S. A list of U.S. projects can be found in Table 6 in the “CMM capture and utilization projects” section of this paper.

6.3. India

India is the third largest producer of coal worldwide, and coal is the most important source of electric power production in India. In 2009, India produced approximately 613,402 thousand short tons of coal and consumed 680,873 thousand short tons, which means that India had to import over 67,400 thousand short tons of coal to meet its domestic demand (U.S. EIA, 2009a). About three-quarters of India's domestic electricity is generated from coal-fired plants. Other large coal users include steel, cement, fertilizer, chemical, paper, and industrial plants, while coal has largely been phased out from the rail transport sector (U.S. EPA, 2009a).

Hard coals (anthracite and bituminous) account for 77% of the country's proved reserves. In 2000, 27% of coal production in India came from underground mines. Currently, that number has dropped to 15%. Deep mines continue to be developed, but more surface mines are also being developed due to the country's vast resource of shallow, low-rank coal deposits (U.S. EPA, 2009a).

The U.S. EPA has estimated India's 2005 CMM emissions to be 19.46 Tg CO₂e. India's carbon emissions are expected to continue to increase throughout the rest of the decade. The rise in India's carbon emissions is in part due to the low energy efficiency of coal-fired power plants in the country. High capital costs of replacing existing coal-fired plants, a scarcity of capital, and the long lead time required to introduce advanced coal technologies point to the likelihood that

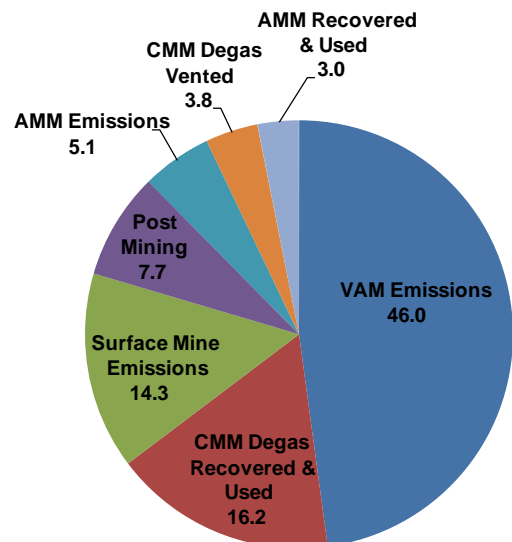

Fig. 28. 2009 CMM emissions by source category. Courtesy of Ruby Canyon Engineering (2010).

most of India's highly polluting coal-fired power plants will remain in operation for the next few decades (U.S. EPA, 2009a).

The Methane to Markets International CMM Projects Database currently identifies no CMM recovery projects in India, neither in operation nor in development (M2M, 2010). There are two proposed projects designed to produce electricity from methane captured at opencast mines in India. While there is some drainage of CMM, there are currently no commercial projects for its recovery or use in India.

About 5% of abandoned mines in India are considered gassy, assuming the same percentage as active mines reported in the First National Communication to the UNFCCC. No additional information is available on abandoned mine methane in India at this time.

7. Benefits of capturing and utilizing CMM and mitigating CMM emissions

There are many benefits for recovering and utilizing CMM, including: reducing greenhouse gas emissions; conserving a local source of valuable, clean-burning energy; enhancing mine safety by reducing in-mine concentrations of methane; and providing revenue to mines (U.S. EPA, 2009e). As a primary constituent of natural gas, methane is an important, relatively clean-burning energy source.

The global coal industry, national governments, trade unions, and worker safety advocates are concerned that the frequency and severity of methane explosions, especially in emerging economies, are unacceptably high. CMM drainage and utilization projects in combination with good safety practices at coal mines could reduce the risk of methane-related explosions by preventing the buildup and migration of in-mine methane.

Effective gas drainage techniques reduce the risks of explosions, and hence lower accident risks. Reducing these risks in turn reduces their associated costs. Costs of methane-related accidents vary widely from country to country but are significant. For example, a 10% work stoppage or idling at a given mine due to a gas-related accident could lead to between US \$8 million and \$16 million/year in lost revenues at a typical high-production longwall mine. Additional costs of a single fatal accident to a large mining operation could range from US \$2 million to more than US \$8 million through lost production, legal costs, compensation, and punitive fines (United Nations, 2010).

Methane capture and use can add significant value to a mining operation. Captured CMM can be directly used to supply or generate energy, harnessing the value of a natural resource. In turn, this can deliver economic returns to the mine through energy sales or cost savings. Moreover, methane utilization adds intrinsic value by generating capital that can be reinvested in mine safety equipment and operations.

CMM capture projects may experience financial benefits from pipeline sales revenue, reduced power, heating and/or cooling costs from onsite electricity generation, and in qualifying countries for carbon reduction credit revenue from GHG reduction programs such as CDM (Clean Development Mechanism), JI (Joint Implementation), and voluntary carbon credits. Revenue streams from carbon emission reduction credits can come in the form of Verified Emission Reductions (VERs), Certified Emission Reductions (CERs), or other credits such as emission reduction units (ERUs). These potential carbon-financing options may be a critical factor in making some CMM utilization projects economically viable that would be otherwise financially unattractive. In addition, carbon financing may provide the only revenue streams for abatement-only projects, such as ventilation air methane (VAM) oxidation (without energy recovery) or CMM flaring. VAM can also be used for electric or thermal power generation. At this time, VAM-derived power generation is not commercially feasible without carbon revenues or other incentives, such as preferential electricity pricing or portfolio standards. VAM projects are reported to deliver positive rates of return at carbon prices starting as low as US \$5–\$10/tCO₂e (United Nations, 2010).

Currently, investment decisions at most mines are likely to favor expansion in coal production rather than development of CMM utilization projects (particularly power generation) due to the high opportunity cost of investing in power generation capital equipment and infrastructure. To meet environmental protection targets in the future, however, mine owners may be required to improve gas drainage performance beyond the level strictly required to meet the safety needs of the mines. Such improvements in the drainage system that yield relatively high-quality gas may provide an additional incentive for investment in gas recovery and utilization projects (United Nations, 2010).

Increased methane recovery also reduces methane-related mining delays, resulting in increased coal productivity (U.S. EPA, 2009d). Furthermore, the development of methane recovery and use projects has been shown to result in the creation of new jobs, which has helped to stimulate area economies. Additionally, the development of local CMM resources may result in the availability of a potentially low-cost supply of gas that could be used to help attract new industry to a region. For these reasons, encouraging the development of CMM recovery and use projects is likely to be of growing interest to state and local governments that have candidate mines in their jurisdictions.

CMM emissions from active underground mines may be mitigated by the implementation of methane drainage systems followed by recovery and use projects. Mines can use several reliable degasification methods to drain methane. These methods have been developed primarily to supplement mine ventilation systems that were designed to ensure that methane concentrations in underground mines remain within safe levels. Degasification systems include vertical wells (drilled from the surface into the coal seam months or years in advance of mining), gob wells (drilled from the surface into the coal seam just prior to mining), and in-mine boreholes (drilled from inside the mine into the coal seam or the surrounding strata prior to mining).

The quality (purity) of the gas that is recovered is partially dependent on the degasification method employed, and may limit how the methane can be used. Potential utilization options for medium- to high-quality CMM (in the range of 30% to 100% methane) include a large variety of applications, such as: (1) use as a fuel in steel furnaces, kilns, and boilers; (2) in internal combustion (IC) engines or turbines for power generation; (3) for injection into natural gas pipelines; (4) as feedstock in the fertilizer industry; or (5) as vehicle fuel in the form of liquid natural gas (LNG) or compressed natural gas (CNG).

Generally, only high-quality gas (usually greater than 95% methane) can be used for pipeline injection. Vertical wells and horizontal boreholes tend to recover nearly pure methane (over 95% methane). In very gassy mines, gob wells can also recover high-quality methane, especially during the first few months of production. Over time, however, mine air may become mixed with the methane produced by gob wells, resulting in a lower quality gas.

Applications for medium-quality (usually greater than 30% methane) gas have been demonstrated in the U.S. and other countries, and include: electricity generation (the electricity can be used either onsite or can be sold to utilities); as a fuel for onsite preparation plants or boilers, or for nearby industrial or institutional facilities; and in cutting-edge applications, such as microturbines or fuel cells.

It is also possible to enrich medium-quality gas to pipeline standards using technologies that separate methane from carbon dioxide, oxygen, and/or nitrogen. Several technologies for separating methane are under development. Another option for improving the quality of mine gas is blending, which is the mixing of lower-quality gas with higher-quality gas whose heating value exceeds pipeline requirements (U.S. EPA, 2009e).

Even mine VAM, which typically contains less than 1% methane, has been successfully demonstrated as an energy source. At a mine in Australia, VAM was successfully used as combustion air in gas-fired internal combustion engines. The application of using mine ventilation air as combustion air in gas turbines and coal-fired boilers has also been

demonstrated. The world's first commercial-scale VAM oxidation project, located in New South Wales, Australia, became operational in September 2007. The plant generates approximately 6 megawatts (MW) of electricity and reduces greenhouse gas emissions by more than 275,000 tCO₂e/year (U.S. EPA, 2009e).

8. CMM utilization technologies

CMM is gathered from underground mines and brought to the surface via vertical frac wells, surface-drilled horizontal wells, gob wells, and centralized vacuum stations, which collect the gas produced by in-mine boreholes and VAM systems (U.S. EPA, 2009d). Not all of the extracted gas is or can be commercially utilized, but depending upon the gas quality and volumes the CMM could be used in a variety of projects, including:

- natural gas pipeline injection;
- power generation;
- ventilation air methane oxidation;
- power electricity generators for the mine or local region;
- use as an energy source—co-firing in boilers, district heating, coal drying;
- use as a vehicle fuel, and manufacturing or industrial uses such as ammonia production;
- flaring.

Currently, commercial CMM utilization is not technically nor economically viable at many CMM drainage projects worldwide. As a result, the drained gas is vented directly to the atmosphere via an exhauster/well head blower. One option to reduce the environmental impact of direct venting is to combust the vented methane in a controlled flare system. CMM flaring has been used successfully in Europe and Australia, but has yet to gain widespread acceptance in the U.S. coal mining industry.

Fig. 29 illustrates several CMM capture and use technologies (and destruction technologies) integrated at an active underground coal mine. The example demonstrates how methane can be used directly to supply or generate energy, which in turn can deliver economic returns for the mine through energy sales or cost savings. Good gas drainage standards and practices will yield gas of stable and usable quality, and will facilitate application of the lowest-cost utilization opportunities. Due to constantly changing mining conditions, gas

supply can fluctuate in quality or quantity; thus utilization equipment will occasionally fail or need to be shut down. In these cases, the unused gas can possibly be flared (if >25% methane) to minimize emissions. Methane that cannot be used nor flared can be diluted in ventilation air and can be oxidized via a VAM destruction technology.

8.1. Pipeline injection

Methane liberated during coal mining may be recovered and collected for sale to interstate pipeline systems. Typical pipeline standards require a methane concentration of 90 to 95%. The key issues that will determine project feasibility are: (1) whether the recovered gas can meet pipeline quality standards; and (2) whether the costs of production, processing, compression, and transportation are competitive with other gas sources.

Gas drained from vertical frac wells, horizontal wells, and in-seam boreholes is usually of sufficient quality (greater than 90% methane) for injection into natural gas pipelines with minimal processing (usually dehydration and carbon dioxide removal) (U.S. EPA, 2009e). Gas from gob wells and cross-measure boreholes is more variable in quality (30–80% methane), depending on the amount of dilution caused by air infiltration into the gob and boreholes. Gob gas and other low-quality gas can reach pipeline quality if it is upgraded or enriched through multi-stage treatment and compressions. Often the gas is transported from individual wells, via an in-field gathering system, to a central processing facility, where it is treated and compressed to meet transmission pipeline specifications.

There are also other options to increase the quality of CMM, such as improving the well and borehole design to improve gas recovery, blending lower-quality CMM with higher-quality CMM, and increasing the energy content of the gas by spiking the CMM with higher hydrocarbon gases.

CMM is collected from the wellbore at relatively low pressures and is compressed to attain the necessary pressure requirements for injection into a transmission pipeline. The number of stages needed for compression will depend on the suction and discharge pressures needed to produce the wells and compress the gas into the transmission line, as well as the compression ratios of the equipment. Three to four stages of compression are common in CBM/CMM projects in the U.S. due to the low suction pressures required to maintain gas production and the high pressures (ranging from 200 to 1500 psig) required for

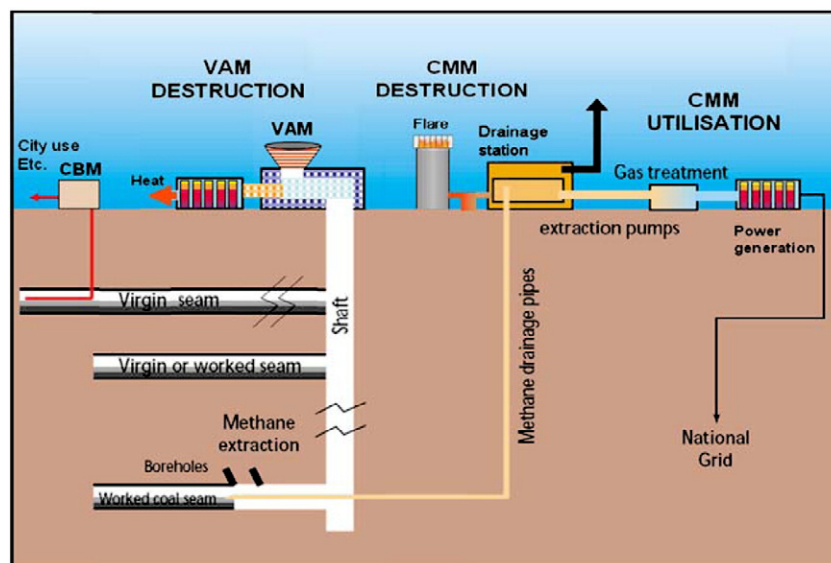

Fig. 29. Multiple CMM end-use and destruction options for underground coal mines. Courtesy of Sindicatum Carbon Capital.

interstate transmission lines. Pipeline injection projects are the most common CMM abatement projects in the U.S.

8.2. Gas processing

An integrated processing plant can be installed at a central facility to remove contaminants and increase the quality of the gas to pipeline specifications. In this process, CMM is treated in a series of connected processes which first remove any hydrogen sulfide present (occasionally found in CMM), followed by removal of excess water vapor, oxygen, carbon dioxide, and nitrogen. In the U.S., pipeline quality gas typically must contain less than 0.2% oxygen, less than 3% nitrogen, less than 2% carbon dioxide, and less than 112 kg/MMcm (7 lbs/MMcf) of water vapor, while having a heating value of greater than 967 Btu/scf (U.S. EPA, 2009d).

Several technologies are commercially used to separate methane from other impurities, while some are still in the field demonstration stage. Nitrogen rejection units (NRU) are used to remove the more difficult and costly nitrogen contaminants. Currently, five technologies are available for methane separation: cryogenic, pressure swing adsorption, solvent absorption, molecular gate, and membrane technologies.

8.2.1. Nitrogen rejection unit (NRU) technologies

8.2.1.1. Cryogenic technology. The cryogenic process uses a series of heat exchangers to liquefy the high-pressure feed gas stream. The mixture is then flashed and a nitrogen-rich stream vents from a distillation separator, leaving the methane-rich stream. Designers locate the deoxygenation system at the plant inlet to avoid the danger of explosion within the plant. Cryogenic plants have the highest methane recovery rate (about 98%) of any of the technologies, and they have become standard practice for large-scale projects where they must achieve economies-of-scale. However, cryogenic plants tend to be less cost-effective at capacities below 5 Mmscf, which are more typical of CMM drainage projects (U.S. EPA, 2008).

8.2.1.2. Pressure swing adsorption (PSA). Gasses when under pressure tend to get adsorbed on solid surfaces. While more gas is adsorbed with a pressure increase, reducing the pressure releases or desorbs the gas. PSA utilizes the property of varying affinities of gasses for a given solid surface to separate a mixture of gasses. In the case of CMM, nitrogen is removed from low-quality gas by passing the gas mixture under pressure through a vessel containing an adsorbent bed that preferentially adsorbs nitrogen, leaving the gas coming out of the vessel to be rich in methane. When the adsorbent bed is saturated, the pressure is reduced to release the adsorbed nitrogen, preparing the bed for another cycle. Usually very porous materials are selected as adsorbents for PSA systems because they provide surface areas large enough to adsorb significant amounts of gas, even though the adsorbed layer may be only one or only a few molecules thick. Adsorbents typically used are activated carbon, silica gel, alumina, and zeolite.

Some specialty adsorbents including zeolites and carbon molecular sieves selectively adsorb gasses based on the size of their molecules; only those gasses that have molecules smaller than the pore size of the adsorbents are allowed into the adsorbent structure. In most PSA NRU systems, wide-pore carbon molecular sieves selectively adsorb nitrogen and methane at different rates in an equilibrium condition. The use of zeolites as an adsorbent for CMM has so far been tested only on the bench scale (U.S. EPA, 2008).

PSA recovers up to 95% of available methane and can operate on a continuous basis with minimal onsite attention. PSA systems have excellent turndown capability, so they are able to operate effectively with gas flowing at a fraction of the rated capacity.

8.2.1.3. Molecular gate. This process removes nitrogen and other contaminants from the methane, whereas other processes remove the

Starting Material – 4 Angstroms

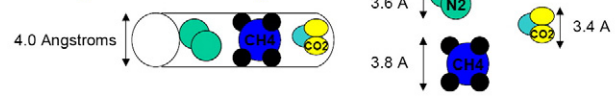

Molecular Gate – Pore Contracted to 3.7 Angstroms

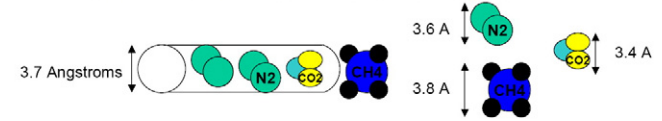

Fig. 30. Molecular gate sieve pore adjustments (U.S. EPA, 2008).

methane from the nitrogen. The process uses a new type of molecular sieve that has the unique ability to adjust pore size openings within an accuracy of 0.1 Å. For CMM, the sieve pore size is set smaller than the molecular diameter of methane and above the molecular diameters of nitrogen, oxygen, carbon dioxide, and water, as indicated in Fig. 30. This permits the nitrogen and other contaminants to enter the pores and to be adsorbed while excluding the methane, which passes through the fixed bed of adsorbent at essentially the same pressure as the feed. The molecular gate process employs a PSA operation by “swinging” the adsorbent bed pressure from a high-pressure feed step that adsorbs the contaminants to a low-pressure regeneration step to remove the previously adsorbed contaminants.

8.2.1.4. Solvent absorption. Sometimes referred to as “selective absorption,” this process uses specific solvents that have different absorption capacities with respect to different gasses. In CMM applications, a solvent selectively absorbs methane while rejecting a nitrogen-rich stream in a refrigerated environment. The petroleum industry commonly uses selective absorption to enrich gas streams.

8.2.1.5. Membrane. This process uses membranes to selectively pass methane, ethane, and higher hydrocarbons while retaining nitrogen. A simple one-stage membrane unit is appropriate for feed gas containing about 6 to 8% nitrogen. However, more commonly, nitrogen concentrations are higher and require a two-step or two-stage membrane system.

8.2.2. Other impurity and water vapor removal technologies

8.2.2.1. Oxygen removal. After nitrogen rejection, deoxygenation is the most technically challenging and expensive process. It is especially important since most pipelines have very strict oxygen limits (typically 0.1% or 1000 parts per million). NRU technologies such as PSA will experience oxygen rejection in proportion to nitrogen rejection and may need very little deoxygenation as a final processing step. Oxygen rejection associated with cryogenic or solvent absorption NRUs is more critical due to explosion danger, and it must be the first system component. Since deoxygenation results in a substantial temperature rise, if inlet gas is likely to contain over 1.5% oxygen, a two-stage recycle system is needed to avoid unacceptably high temperatures.

8.2.2.2. Carbon dioxide removal. Several technologies are available commercially, including amine units, membrane technology, and selective adsorption. Amine units are tolerant of only low levels of oxygen in the feed stream, so the amine unit must be downstream of the de-oxygenation unit (U.S. EPA, 2008). Often amine systems are used to treat gas removed from virgin coal beds, but an adsorption system may be more attractive for treating highly contaminated gas such as gob gas or abandoned mine CMM. However, amine systems may experience corrosion and degradation from the amine solvents used in the process. Amine systems commonly operate at high pressure and require compression of the feed gas. The gas stream from

amine units is often water-saturated and a glycol dehydration unit is used to bring the gas to pipeline specifications (Michael Mitariten, 2009).

8.2.2.3. Water vapor removal. Dehydration of CMM is the simplest part of any integrated system design. Inadequate water removal, however, can result in corrosion damage to delivery pipes and can be quite serious. Most system suppliers will employ a molecular sieve dehydration stage because of its proven record and economical operation.

8.2.3. Other CMM upgrading options

Horizontal boreholes and “longhole” horizontal boreholes also can produce pipeline quality gas when the integrity of the in-mine piping system is closely monitored. However, the amount of methane produced from these methods is sometimes not large enough to warrant investments in the necessary surface facilities. In cases where mines are developing utilization strategies for larger amounts of gas recovered from vertical or gob wells, it may be possible to use the gas recovered from in-mine boreholes to supplement production.

Another option to upgrade gas quality is to blend the low Btu gas with higher Btu gas to obtain a higher heating value above the pipeline quality requirements. As a result of blending, the Btu content of the overall mixture can meet acceptable levels for pipeline injection. Spiking the CMM with higher hydrocarbon gasses such as propane is also an option, but this application is dependent upon the pipeline's acceptance of spiked gas. Gas processing may still be required in combination with improved extraction techniques, blending, and spiking in order to meet pipeline specifications.

8.3. Power generation

CMM may also be used as a fuel for power generation. Unlike pipeline injection, power generation does not require pipeline-quality methane nor much compression. Gas engines can generate electricity using methane that has a heat content of 350 Btu/cf (U.S. EPA, 2009e). Mines can use electricity generated from recovered methane to meet their own onsite electricity requirements, and they can sell electricity generated in excess of their onsite needs to utilities. Outside of the U.S., power generation is often the preferred option for using CMM. Power generation projects using CMM are operating at coal mines in several countries, including China, Australia, the United Kingdom, and Germany.

Currently, reciprocating or internal combustion (IC) engines are the most likely technology to be used for a CMM project. Boiler/steam turbines are generally not cost-effective in sizes below 30 MW, while gas turbines are not the optimal choice for projects requiring 10 MW or less. Furthermore, gas turbines typically cannot utilize CMM below 50% methane and require the gas to be compressed prior to use. However, when used in the right applications, gas turbines are smaller and lighter than IC engines, more efficient, and historically have had lower operation and maintenance costs.

While maintaining pipeline quality gas output from gob wells can be difficult, the heating value of gob gas is generally compatible with the combustion needs of gas engines. One potential problem with using gob gas is that production, methane concentration, and rate of flow are generally not predictable—wide variations in the Btu content of the fuel may create operating difficulties. Equipment for blending the air and methane may be needed to ensure that variations in the heating value of the fuel remain within an acceptable range for gas engines and possess approximately 10% allowable variability for gas turbines.

The level of electric capacity that may be generated depends on the amount of methane recovered and the “heat rate” (i.e., Btu to kWh conversion) of the generator. For example, simple cycle gas turbines typically have heat rates in the range of 10,000 Btu/kWh, while

combined cycle gas turbines could have heat rates of 7000 Btu/kWh (U.S. EPA, 2009e). Gas engine heat rates can range from 9000 to 11,000 Btu/kWh, depending on the model of the engine.

8.3.1. Ventilation air methane (VAM) use technologies

VAM, the dilute methane emitted from mine ventilation shafts, is now recognized as an unused source of energy. A host of recently introduced technologies can reduce VAM emissions, while harnessing thermal energy, and can offer significant benefits to the world community.

A limited number of technologies that can beneficially use VAM are currently available, while others are in the development and demonstration phase. One existing approach is quite straightforward and entails using VAM as combustion air, thereby supplying ancillary fuel to internal combustion (IC) engines, turbines, or industrial and utility boilers. Such VAM use in IC engines (running on CMM) has been well-demonstrated in Australia.

In recent years, technologies have been developed that can destroy very low concentration methane in mine ventilation air by thermal oxidation. The primary purpose of these technologies is the reduction of GHG emissions. Some of these technologies may be combined with a heat recovery system for use at mines or district heating, or to run steam turbines for power generation.

8.3.1.1. Thermal oxidation technologies. Flow-reversal oxidizers – both thermal and catalytic – are commercially available and are capable of oxidizing VAM. VAM entering thermal oxidizers encounters a bed of heat exchange material that has been preheated to the oxidation temperature of methane (1000 °C). The VAM oxidizes and releases heat, which in turn maintains the temperature of the heat transfer material at or above 1000 °C, thereby sustaining the auto-oxidation process over time without requiring additional fuel input. Valves and dampers repeatedly reverse the flow of incoming VAM to keep the hot zone in the center of the oxidizer. Catalytic and thermal systems both operate on this principle, although catalysts allow the reaction to occur at lower temperatures (~800 °C). When VAM concentrations are high enough, these systems can also provide excess heat energy for electricity generation (U.S. EPA 2009f).

The U.S. EPA has identified several commercially viable technologies for destroying or beneficially using the methane contained in ventilation air:

- two technologies based on a thermal oxidation process using thermal flow-reversal reactors (TFRR) also known as regenerative thermal oxidizers (RTO);
- a catalytic oxidation process called the catalytic flow-reversal reactor (CFRR) also known as regenerative catalytic oxidizers (RCO).

These technologies employ similar principles to oxidize methane contained in mine ventilation airflows. Based on the latest demonstration projects, these units can sustain operation (i.e., maintain oxidation) with ventilation air having uniform methane concentrations down to approximately 0.1% and 0.2% for the CFRR and TFRR processes, respectively. For commercial applications where methane concentrations are likely to vary over time, the economic lower concentration limit at which oxidizers will be deployed is 0.5%. VAM energy recovery has been successfully demonstrated in Australia, using RTOs to convert VAM to electricity at a mine mouth power plant. A VAM RCO has been proven at full-scale demonstration in a test unit (Somers and Shultz, 2008).

8.3.1.2. Thermal flow-reversal reactors. TFRR equipment consists of a bed of silica gravel or ceramic heat-exchange medium with a set of electric heating elements in the center. The TFRR process employs the principle of regenerative heat exchange between a gas and a solid bed of heat-exchange medium. To start the operation, electric heating elements preheat the middle of the bed to the temperature required

to initiate methane oxidation (above 1000 °C or 1832 °F, or hotter). Ventilation air at ambient temperature enters and flows through the reactor in one direction, and the air temperature increases until oxidation of the methane takes place near the center of the bed.

The hot products of oxidation continue through the bed, losing heat to the far side of the bed in the process. When the far side of the bed is sufficiently hot, the reactor automatically reverses the direction of ventilation airflow. The ventilation air now enters the far (hot) side of the bed, where it encounters auto-oxidation temperatures near the center of the bed and then oxidizes. The hot gasses again transfer heat to the near (cold) side of the bed and exit the reactor. Finally, the process is reversed again. Fig. 31 shows an example of a thermal flow-reversal reactor system.

8.3.1.3. Catalytic flow-reversal reactors. CFRRs adapt the thermal flow-reversal technology described above by including a catalyst to reduce the auto-oxidation temperature of methane by several hundred degrees Celsius (to as low as 350 °C or 662 °F). CFRR technology was developed exclusively for the treatment of methane in coal mine ventilation air (U.S. EPA, 2009e). Injecting a small amount of methane (gob gas or other source) increases the methane concentration in ventilation air and can make the turbine function more efficiently. Waste heat from the oxidizer is also used to pre-heat the compressed air before it enters the expansion side of the gas turbine.

There are two primary options for converting the heat of oxidation from a flow-reversal reactor to electric power, which is the most marketable form of energy in most locations:

- Using water as a working fluid: In this process, the water is pressurized and forced through an air-to-water heat exchanger in a section of the reactor that will provide a non-destructive temperature environment (below 800 °C or 1472 °F). The hot pressurized water is flashed to steam and the steam is used to drive a steam turbine-generator. If a market for steam or hot water is available, the exhausted steam is sent to that market. If none is available, the steam is condensed and the water returned to the pump to repeat the process.
- Using air as a working fluid: In this process, ventilation air or ambient is pressurized and sent through an air-to-air heat exchanger that is embedded in a section of the reactor that stays below 800 °C (1472 °F). The compressed hot air is directed through a gas turbine-generator. If gob gas is available, it is used to raise the temperature of the working fluid to more nearly match the design temperature of the turbine inlet. If thermal markets are available, the turbine exhaust is used for cogeneration.

Since affordable heat exchanger temperature limits are below those used in modern prime movers, efficiencies for both of the

energy conversion strategies listed above will be fairly modest. The use of a gas turbine, the second method listed, is the energy conversion technology assumed for the cost estimates in this paper. At a VAM concentration of 0.5%, it is expected that an overall plant efficiency of approximately 17% will be achieved after accounting for power allocated to drive the fans that force ventilation air through the reactor.

Current VAM technologies are generally not able to process methane concentrations below 0.2% without the use of an additional fuel, but research efforts are underway to lower the concentration threshold since VAM concentrations at many mines worldwide fall below 0.2% (United Nations, 2010). Operations that use VAM to generate power may need to optimize the inflow concentrations and increase the VAM concentration inlet to the oxidation device.

One method of fuel enrichment (spiking) involves adding methane from other sources such as gob or pre-mine drainage gas. If enrichment is being considered, low-quality drained gas (less than 30%) should not be used due to the explosion hazard. Use of higher-concentration gas (greater than 30%) could divert gas from lower-cost CMM power generation, and this should be evaluated as part of the project feasibility.

Other VAM technologies under development include the catalytic monolith reactor (CMR), lean-burning turbines reported to use VAM at concentrations of 1.5% and lower, and rotary kilns that mix VAM with waste coal fines.

8.3.2. Onsite use options of CMM by coal mines

In addition to pipeline injection, power generation, and VAM use, CMM may be used as a fuel in onsite preparation plants or vehicle refueling stations, or it can be transported to a nearby coal-fired boiler or other industrial or institutional facilities for direct use.

Many large underground coal mines have preparation plants located nearby. Mines have traditionally used their own coal to fuel these plants, but there is the potential to use recovered methane instead. Currently in the U.S., a major mining company uses recovered methane to fuel the thermal dryer in one of its preparation plants in the U.S. In Poland, while several coal mines have used recovered methane to fuel their coal drying plants.

Another option for onsite methane use may be as a fuel for vehicles as CNG or LNG. Natural gas is much cheaper and cleaner than diesel fuel or gasoline, and internal combustion engines burn it more efficiently. Current estimates indicate that nearly 4000 vehicles operating in China use CMM as fuel (Jianmin and Shengchu, 2010).

In addition to onsite methane use, selling recovered methane to a nearby industrial or institutional facility may be a promising option for some mines. An ideal gas customer would be located near the coal mine (within 5 km) and would have a continuous demand for

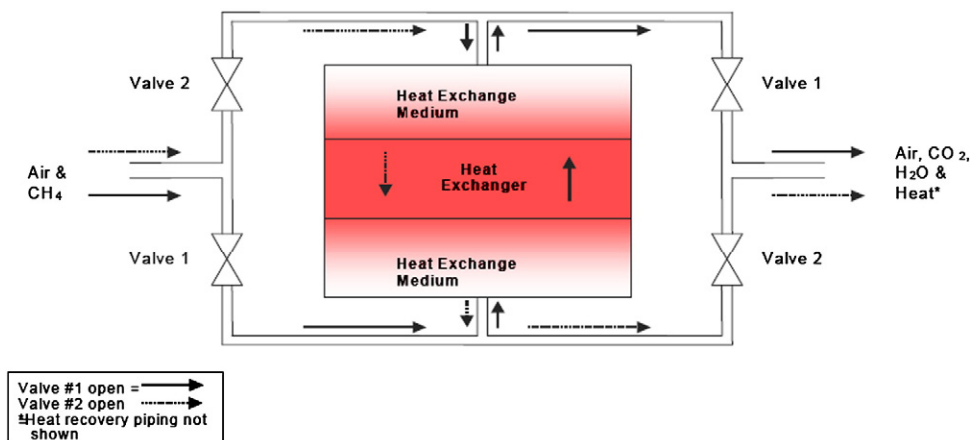

Fig. 31. Depiction of the thermal flow-reversal reactor process (U.S. EPA, 2008).

gaseous fuel. CMM could be used to fuel a cogeneration system, to fire boilers or chillers, or to provide space heating. In China, medium-quality CMM is often used in local communities for residential cooking and heating purposes. In some cases, local communities may find that the availability of an inexpensive fuel source from their local mine can help them attract new industries and generate additional jobs.

Additionally, there are numerous international examples of mine gas being used for industrial purposes. For example, in the Ukraine and Russia, recovered CMM is used in coal-fired boilers located at the mine site. In the Czech Republic, CMM is used in nearby metallurgical plants. In Poland, recovered CMM is used as a feedstock fuel in a chemical plant. In China, CMM has been used in aluminum smelters and carbon black plants. Finally, co-firing methane with coal in a boiler is another potential utilization option, particularly for mines that are located in close proximity to a power plant.

The flaring of CMM is an abatement option that may be attractive if CMM utilization is not feasible. Typically, flaring is a low-cost technology with short manufacturing and installation time periods (Harworth Energy, 2010). Coal mines using flares to combust CMM generally collect the gas from gob wells via an active compression system (a system using a mechanical blower/exhauster). Flares are either open “candlestick” or enclosed (ground) flares with destruction efficiencies of approximately 98% and 99% respectively; however, open flare efficiencies can be decreased by high crosswinds, high CO₂, and other factors (U.S. EPA, 1999). To install a flare a mine must have a gas drainage system capable of draining methane above 25% purity (Harworth Energy, 2010).

Preferably, each utilization project should be equipped with a flare in case of equipment malfunction, when scheduled maintenance requires that the project be shut down temporarily, or during the early mine development stage when methane production has not yet reached commercially viable levels. Also, this action can accommodate any excess methane not being used by the project.

For the purposes of attaining carbon credits, the Clean Development Mechanism (CDM) Executive Board has established rather low default values of 90% for enclosed flares and 50% for open flares. Actual efficiencies can be measured and monitored for enclosed flares, but not for open flares. A final consideration is that enclosed flares have greater esthetic appeal in that the flame is not visible and combustion pollutants can be better managed (United Nations, 2010).

The coal industry and mine regulatory authorities in some countries have opposed flaring at mines over concerns that the flame could propagate back down through the drainage system into the mine, causing an explosion. At the very least, safe flaring requires rigorous design incorporating flame and detonation arrestors, seals, sensors, and other safety devices. That said, CMM flares have operated successfully in a number of countries including Australia, China, and the United Kingdom.

In the U.S., flaring has not been implemented due to the coal industry's primary concern for safety and preventing flame propagation that could lead to underground explosions. The U.S. EPA Reports Conceptual Design for a Coal Mine Gob Well Flare (U.S. EPA, 1999) and Benefits of an Enclosed Gob Well Flare Design for Underground Coal Mines (U.S. EPA, 2000) contain further information on flaring and the benefits of flaring.

8.4. Emerging technologies

The U.S. EPA has also identified other technologies that may be able to play a role in and enhance opportunities for VAM oxidation projects. These new technologies include volatile organic compound (VOC) concentrators, lean gas fuel turbines, and using VAM as an ancillary fuel. Each emerging technology is briefly described in the subsections that follow.

8.4.1. Concentrators

Volatile organic compound (VOC) concentrators offer another possible economical option for application to VAM. Currently there are three technologies available: the carousel, rotary disk, and fluidized bed, with the fluidized bed considered to be the most applicable technology to concentrating CMM (U.S. EPA, 2010b). Concentrators operate by passing the methane-laden air up through a bed of adsorbent material (e.g., activated carbon or zeolite beads) on which the methane accumulates, increasing the weight of the adsorbent, which falls downward. An inert carrier gas is used to strip the methane in a desorption step; the adsorbent is then returned to the fluidized bed for another concentration cycle.

The benefits of a concentrator include increasing the concentration of methane in VAM for use in turbines and IC engines, reducing the upgrading requirements for pipeline injection of mid-quality gas, and increasing the commercial use options for low-quality gas streams.

8.4.2. Lean fuel gas turbines

Currently efforts are underway to modify selected gas turbine models to operate directly on VAM or on VAM that has been enhanced with more concentrated fuels. These efforts include technologies such as carbureted gas turbines, lean-fueled turbines with catalytic combustors, lean-fueled catalytic microturbines, hybrid coal and VAM-fueled gas turbines, and the use of VAM as an ancillary fuel. These technologies are briefly discussed below. More information on these emerging technologies is available in the U.S. EPA paper, “Identifying Opportunities for Methane Recovery at U.S. Coal Mines: Profiles of Selected Gassy Underground Mines 2002–2006” (U.S. EPA, 2009e).

8.4.3. Carbureted gas turbine (CGT)

A carbureted gas turbine is a gas turbine in which the fuel enters as a homogeneous mixture via the air inlet to an aspirated turbine. It requires a fuel/air mixture of 1.6% by volume, so most VAM sources would require enrichment. Combustion takes place in an external combustor where the reaction is at a lower temperature (1200 °C or 2192 °F) than for a normal turbine, thus eliminating any NO_x emissions.

8.4.4. Lean-fueled turbine with catalytic combustor (CCGT)

A lean-fueled turbine with catalytic combustor gas turbine is under development by CSIRO Exploration & Mining of Australia. This turbine could use methane in coal mine ventilation air and could oxidize the VAM in conjunction with a catalyst. The turbine compresses a very lean fuel/air mixture and combusts it in a catalytic combustor.

8.4.5. Lean-fueled catalytic microturbine

A lean-fueled catalytic microturbine is being jointly developed by two U.S. companies, FlexEnergy and Capstone Turbine Corporation. The application will start at 30 kW and will operate on a methane-in-air mixture of 1.3%. Capstone microturbines have been successfully demonstrated utilizing CMM at an abandoned mine in Japan in 2004.

8.4.6. Hybrid coal and VAM-fueled gas turbine

CSIRO is developing a system to oxidize and generate electricity with VAM in combination with waste coal. CSIRO is constructing a 1.2-MW pilot plant that co-fires waste coal and VAM in a rotary kiln, captures the heat in a high-temperature air-to-air heat exchanger, and uses the clean, hot air to power a gas turbine.

8.5. Benefits and disadvantages of end-use technologies

Each end-use technology has associated advantages and disadvantages. Table 4 summarizes the most common advantages and

Table 4
Summary of advantages and disadvantages of end-use technologies.

Use	Applications	Advantages	Disadvantages
High-quality pipeline gas	Purified high-quality CMM.	<ul style="list-style-type: none"> Natural gas equivalent. Profitable where gas prices strong. Good option where strong pipeline infrastructure exists. Proven technology. 	<ul style="list-style-type: none"> Pipeline purity standards are high and purification is costly. Only feasible for high-quality, pre-drained CMM or treated CMM. Requires reasonable access to pipeline.
Power generation	Gas-engine generators producing power for mine use or export to the grid.	<ul style="list-style-type: none"> Waste heat recovery for heating mine buildings, miner baths, and shaft heating and cooling. 	<ul style="list-style-type: none"> Interruptible and variable output; therefore, may not be conducive for the electric grid. Regular maintenance requires commitment of mine operator.
VAM flow reversal oxidizers	Destruction of dilute concentrations of methane often less than 1% in VAM. Potential for waste heat recovery for energy generation.	<ul style="list-style-type: none"> Destruction of large source of CMM emissions. Can capture waste heat for water or space heating. 	<ul style="list-style-type: none"> High capital costs at initial stage of project. High capital costs at initial stage of project.
VAM as combustion air	Using VAM as combustion air to supply ancillary fuel to combustion devices.	<ul style="list-style-type: none"> Destruction of large source of CMM emissions. Can be used to generate electricity for onsite or offsite use. 	<ul style="list-style-type: none"> Regular maintenance requires commitment of mine operator. High capital costs at initial stage of project.
Medium-quality "town" or industrial gas	>30% methane for local residential, district heating and industrial use such as firing kilns.	<ul style="list-style-type: none"> Low-cost fuel source. Localized benefits. May require minimal or no gas cleanup. 	<ul style="list-style-type: none"> Cost of distribution system and maintenance. Variable quality and supply. Costly gas holders needed to manage peak demands.
Chemical feedstock	High-quality gas for the manufacture of carbon black, formaldehyde, synthetic fuels, and di-methyl ether (DME).	<ul style="list-style-type: none"> A use for stranded high-quality CMM supplies. 	<ul style="list-style-type: none"> High processing cost. No CDM potential when carbon can be liberated.
Mine Site	Heating, cooking, boilers, coal fines drying, miner's residences.	<ul style="list-style-type: none"> Displaces coal use. Clean, low-cost energy source. 	<ul style="list-style-type: none"> May be less economically beneficial to use onsite than off-site.
Vehicles	Purified high-quality, pre-drained gas and CBM for CNG and LNG.	<ul style="list-style-type: none"> Market access for stranded gas supplies. 	<ul style="list-style-type: none"> Processing, storage, handling, and transport costs.
Flaring	Destruction of drained CMM or excess CMM from other utilization technologies.	<ul style="list-style-type: none"> Vehicle fuel prices are very high. Generally low-cost destruction option. Destruction efficiencies between 98% and 99%. 	<ul style="list-style-type: none"> Purification standards are very high. Generally requires a methane concentration of 30%. Concerns over safety of flares at mining locations.

disadvantages for each of the primary end-use technologies utilized at coal mines globally.

9. CMM project barriers and a global overview of projects

9.1. Barriers to the recovery and use of CMM

Currently, a number of commercial and institutional barriers (and other project risks) can alter the ultimate economic viability of CMM projects. These obstacles include technical challenges with varying gas quality and quantity, unresolved legal issues concerning ownership of the CMM resource, lack of pilot projects for new technologies to demonstrate site-specific economic recovery and utilization, lack of financing or capacity to obtain financing, and pipeline locality and/or capacity constraints.

The above constraints will vary from country to country. For example, in China, barriers to CMM development include lack of accessibility to pipeline networks and limited drainage technologies and low drainage rates. In the U.S., unresolved legal issues (especially of federal lands in the western U.S.) and lack of financing present larger challenges to CMM project development. Conversely, mine locality-to-pipeline networks and access to highly efficient CMM drainage technologies are not barriers in the U.S. (U.S. EPA, 2009a). The barriers and constraints for some of the large CMM-emitting countries are presented in Table 5.

9.2. CMM capture and utilization projects

The Methane to Markets Partnership (M2M) is an international initiative that advances cost-effective, near-term methane recovery and use as a clean energy source. The goal of the Partnership is to

Table 5
Constraints to CMM development for top CMM-emitting countries.

Country	Primary constraints
China	<ul style="list-style-type: none"> Most mines are not accessible to gas pipeline network. Limited drainage technologies/low drainage rates. Regulations for foreign project developers may be unclear. Most CMM is low-grade, i.e., less than 30% methane.
United States	<ul style="list-style-type: none"> In much of the U.S. (especially in western states) there is limited pipeline capacity relative to supply. Relatively low electricity prices have made power projects (either for onsite use or sales to a utility) less attractive. Ownership of carbon-based mineral rights are often divided between oil/natural gas and coal.
Russia	<ul style="list-style-type: none"> CMM and CBM must compete with large, in-country proven gas resources with low-cost production capacity. The region lacks the technological capability to extract CBM economically from saturated, low-permeability coal seams. There is a general lack of state support for unconventional fuel production (M2M Workshop—Russia, 2005). Most CMM is low-grade, i.e., less than 30% methane.
Australia	<ul style="list-style-type: none"> Power generation costs are relatively high—may not be able to pass on the full cost of emission credits in market power prices.
Ukraine	<ul style="list-style-type: none"> Methane in coal is owned by state but assigned to companies, mines, and individuals and rights to methane are not easily transferred. Most coal enterprises are not profitable, and only a few have seen significant private investment. Most CMM is low-grade, i.e., less than 30% methane.
India	<ul style="list-style-type: none"> Lack of clarity about legal and regulatory issues, especially ownership of the gas. Lack of technology and technical knowledge. Lack of CMM resource assessment, technology selection, and formulation of feasibility studies. Lack of pilot projects to demonstrate site-specific economic recovery and utilization. Lack of infrastructure to utilize gas. Lack of financing or capacity to obtain financing.

from the coal seam itself or from other gassy formations underground. The high amounts of methane released during coal mining can present concerns about adequately ventilating the mine for ensuring the safety of workers and about providing opportunities to generate energy if the methane were captured and utilized properly. This article reviewed the technical aspects of CMM capture in and from coal mines, the main factors affecting CMM accumulations in underground mines, different methods for capturing and utilizing methane using boreholes, mine safety aspects of capturing CMM, and global CMM emissions and activities for energy production and greenhouse gas (GHG) reduction.

CMM is set apart from CBM (coalbed methane) in that CMM activities are associated with coal mining activities, whereas CBM is not associated with any particular coal mining operation. There are many factors that affect the quantity of CMM emissions during mining in addition to coal reservoir properties. In addition, the gas produced in CMM activities can be either high-quality gas, such as methane produced in advance of mining, or low-methane concentration gas, such as VAM. The gas produced from gobbs of sealed and active longwall mines and from abandoned mines can be considered as medium-quality gas, since it is often contaminated with air.

CMM capture using boreholes during mining in the pre- and post-mining phases fundamentally utilizes the same techniques that are used or adapted from conventional CBM operations. Therefore, most of the time, similar geological factors, borehole drilling and completion, and production evaluation methods apply. However, in CMM activities, the projected locations of future mines and the current locations of existing operations should be taken into account and the boreholes drilled and completed accordingly. Also, in CMM-capture activities, borehole stability becomes a more important issue for sustaining production. This is especially important for GGVs where the overlying strata fracture and displace, possibly damaging the production casing.

Depending on the quality of CMM gas produced, it can be directly injected into a pipeline to be utilized as town gas, or it can be improved by removing the contaminants, such as oxygen and nitrogen. There are available and demonstrated technologies for improving the quality of CMM. In the case of VAM, it is costly and almost impossible to upgrade it to pipeline-quality gas. Thus, different engines and reactors are used to generate power from this low-methane-content energy source. These technologies have been demonstrated and are being successfully used in the U.S. and in Australia.

The countries with the most CMM emissions are China, the United States, Australia, the Ukraine, India, and Russia. Recognizing the importance of capturing and using CMM for mine safety, energy production, and greenhouse gas reduction, these countries are implementing various CMM projects. However, depending on the economic, social, and regulatory conditions in each of these countries (and also in other CMM-emitting countries), the implementation of different CMM projects are faced with multiple challenges that may slow down or curtail their progress. These challenges must be addressed and resolved with the collaboration of both government agencies and the private sector in each country, and also through cooperation on an international level by funding and demonstration of the importance of CMM capture and utilization to improve mining safety, energy production, and greenhouse gas reductions. Along these lines, the Global Methane Initiative, currently made up of 38 partner countries, engages both governments and private sector entities, bringing together the technical and market expertise, financing, and technology necessary for methane capture and utilization at an international level.

Disclaimer

The findings and conclusions in this paper are those of the authors and do not necessarily represent the views of the National Institute for Occupational Safety and Health. Any commercial product or

software mentioned in this paper is not endorsed by NIOSH nor the U.S. EPA.

References

- Alsaab, D., Elie, M., Izart, A., Sachsenhofer, R.F., Privalov, V.A., Suarez-Ruiz, I., Martinez, L., Panova, E.A., 2009. Distribution of thermogenic methane in Carboniferous coal seams of the Donets Basin (Ukraine): "applications to exploitation of methane and forecast of mining hazards". *International Journal of Coal Geology* 78, 27–37.
- Aul, G.N., Ray, R., 1991. Optimizing methane drainage systems to reduce mine ventilation requirements. 5th US Mine Ventilation Symposium, Morgantown, WV, June 3–5.
- Ayers, D., 2002. Coalbed gas systems, resources and production and a review of contrasting cases from the San Juan and Powder River Basins. *AAPG Bulletin* 85, 1853–1890.
- Banks, S.B., Banks, D., 2001. Abandoned mines drainage: impact assessment and mitigation of discharges from coal mines in the UK. *Engineering Geology* 60, 31–37.
- Beamish, B.B., Crosdale, P.J., 1998. Instantaneous outbursts in underground coal mines: an overview and association with coal type. *International Journal of Coal Geology* 35, 27–55.
- Beaton, A., Langenberg, W., Pana, C., 2006. Coalbed methane resources and reservoir characteristics from Alberta Plains, Canada. *International Journal of Coal Geology* 65, 93–113.
- Bibler, C.J., Marshall, J.S., Pilcher, R.C., 1998. Status of worldwide coal mine methane emissions and use. *International Journal of Coal Geology* 35, 283–310.
- Bohan, M.P., 2009. Directional drilling techniques provide options for coal mine methane (CMM) drainage. 9th International Mine Ventilation Congress, 10–13 November, New Delhi, India.
- Boyer, C.M., Qingzhao, B., 1998. Methodology of coalbed methane resource assessment. *International Journal of Coal Geology* 35, 349–368.
- Bustin, M.R., Clarkson, C.R., 1998. Geological controls on coalbed methane reservoir capacity and gas content. *International Journal of Coal Geology* 38, 3–26.
- Calder, J.H., 1993. The evolution of a ground-water-influenced (Westphalian B) peat-forming ecosystem in a piedmont setting: the No. 3 Seam, Springhill Coalfield, Cumberland Basin, Nova Scotia. In: Cobb, J.C., Cecil, C.B. (Eds.), *Modern and Ancient Coal-Forming Environments: GSA Special Paper*, 286, pp. 153–181.
- Cameron, J.R., Palmer, I.D., Lukas, A., Moschovidis, Z.A., 2007. Effectiveness of horizontal wells in CBM. *International Coalbed Methane Symposium*, Paper 0716. The University of Alabama, Tuscaloosa, AL.
- Cao, Y., He, D., Glick, D.C., 2001. Coal and gas outbursts in footwalls of reverse faults. *International Journal of Coal Geology* 48, 47–63.
- Cheng, Y.-P., et al., 2011. Environmental impact of coal mine methane emissions and responding strategies in China. *International Journal of Greenhouse Gas Control* 5 (1), 157–166.
- Clarkson, C.R., Bustin, R.M., 1996. Variation in micropore capacity and size distribution with composition of Cretaceous coals of the Western Canadian Sedimentary Basin. *Fuel* 75, 1483–1498.
- Collings, R.C., 2003. Numerical simulation of coal mine methane recovery. *Fraunhofer UMSICHT Oberhausener Grubengas-Tage* 2003.
- Colmenares, L.B., Zoback, M.D., 2007. Hydraulic fracturing and wellbore completion of coalbed methane wells in the Powder River basin, Wyoming: implications for water and gas production. *AAPG Bulletin* 91, 51–67.
- Coolen, J.M., 2003. Coal mining along the Warfield Fault, Mingo County, West Virginia: a tale of ups and downs. *International Journal of Coal Geology* 54, 193–207.
- Coward, H.F., Jones, G.W., 1952. Limits of flammability of gases and vapors. *US Bureau of Mines Information Circular No. 503*, 155 pp.
- Creeedy, D.P., 1993. Methane emissions from coal related resources in Britain: development of a methodology. *Chemosphere* 26, 419–439.
- Crosdale, P.J., Beamish, B.B., Valix, M., 1998. Coalbed methane sorption related to coal composition. *International Journal of Coal Geology* 35, 147–158.
- Dake, L.P., 1978. *Fundamental of Reservoir Engineering*. Elsevier, Amsterdam, 443 pp.
- Diamond, W.P., 1982. Site-specific and regional geologic considerations for coalbed gas drainage. *Information Circular No. 8898*. US Dept. of Interior, US Bureau of Mines, Pittsburgh, PA.
- Diamond, W.P., 1994. Methane control for underground coal mines. *US Bureau of Mines Information Circular No. 9395*, Pittsburgh, PA.
- Diamond, W.P., La Scola, J.C., Hyman, D.M., 1986. Results of direct method determination of the gas content of the US coal beds. *US Bureau of Mines Information Circular No. 9067*, Pittsburgh, PA.
- Diessel, C., Boyd, R., Wadsworth, J., Leckie, D., Chalmers, G., 2000. On balanced and unbalanced accommodation/peat accumulation ratios in the Cretaceous coals from Gates Formation, Western Canada, and their sequence-stratigraphic significance. *International Journal of Coal Geology* 43, 143–186.
- Dougherty, H., Karacan, C.Ö., 2010. A new methane control and prediction software suite for longwall mines. *Computers and Geosciences*. doi:10.1016/j.cageo.2010.09.003.
- Durucan, S., Shi, J.Q., Korre, A., 2004. Numerical modeling and prediction of abandoned mine methane recovery: field application at the Saar Coalfield, Germany. *Geologica Belgica* 7, 207–213.
- Flores, R.M., 1998. Coalbed methane: from hazard to resource. *International Journal of Coal Geology* 35, 3–26.
- Gentzis, T., 2009. Stability analysis of a horizontal coalbed methane well in the Rocky Mountain Front Ranges of southeast British Columbia, Canada. *International Journal of Coal Geology* 77, 328–337.
- Gentzis, T., Deisman, N., Chalaturnyk, R.J., 2009. Effect of drilling fluids on coal permeability: impact on horizontal wellbore stability. *International Journal of Coal Geology* 78, 177–191.

- Greb, S.F., Eble, C.F., Williams, D.A., Nelson, W.J., 2001. Dips, ramps and rolls—evidence for paleotopographic and syn-depositional fault control on the Western Kentucky No. 4 Coalbed, Tradewater Formation (Bolsovian), Illinois Basin. *International Journal of Coal Geology* 45, 227–246.
- Gurdal, G., Yalcin, M.N., 2000. Gas adsorption capacity of Carboniferous coals in the Zonguldak Basin (NW Turkey) and its controlling factors. *Fuel* 79, 1913–1924.
- Han, J.-Z., Sand, S.-X., Cheng, Z.-Z., Huang, H.-Z., 2009. Exploitation technology of pressure relief coalbed methane in vertical surface wells in the Huainan coal mining area. *Mining Science and Technology* 19, 0025–0030.
- Harworth Energy, 2010. From coal face to grid coal mine methane as a resource. Methane to Markets Partnership Expo.: A Forum for Projects, Technology, Financing and Policy, 2–5 March, New Delhi, India.
- Holditch, S.A., 1990. Completion methods in coal seam reservoirs. *Ann. Tech. Conf. New Orleans, LA. SPE* 20670. September.
- Jianmin, W., Shengchu, Huang, 2010. Current status and policy from works of methane emission reduction in China. Methane to Markets Presentation.
- Johnson, W.J., Snow, R.E., Clark, J.C., 2002. Surface geophysical methods for detection of underground mine workings. Symposium on Geotechnical Methods for Mine Mapping Verifications, Charleston, West Virginia, October 29.
- Karacan, C.Ö., 2007a. Swelling-induced volumetric strains internal to a stressed coal associated with CO₂ sorption. *International Journal of Coal Geology* 72, 209–220.
- Karacan, C.Ö., 2007b. Development and application of reservoir models and artificial neural networks for optimizing ventilation air requirements in development mining of coal seams. *International Journal of Coal Geology* 72, 221–239.
- Karacan, C.Ö., 2008a. Modeling and prediction of ventilation methane emissions of U.S. longwall mines using supervised artificial neural networks. *International Journal of Coal Geology* 73, 371–387.
- Karacan, C.Ö., 2008b. Evaluation of the relative importance of coalbed reservoir parameters for prediction of methane inflow rates during mining of longwall development entries. *Computers and Geosciences* 34, 1093–1114.
- Karacan, C.Ö., 2009a. Forecasting gob gas venthole production using intelligent computing methods for optimum methane control in longwall coal mines. *International Journal of Coal Geology* 79, 131–144.
- Karacan, C.Ö., 2009b. Reconciling longwall gob gas reservoirs and venthole production performances using multiple rate drawdown well test analysis. *International Journal of Coal Geology* 80, 181–195.
- Karacan, C.Ö., 2010. Methane control and prediction (MCP) software (version 2.0). <http://www.cdc.gov/niosh/mining/products/product180.htm>.
- Karacan, C.Ö., Diamond, W.P., 2006. Forecasting gas emissions for coal mine safety applications. In: Kissell, F. (Ed.), *Handbook for Methane Control in Mining*. Information Circular No: 9486. NIOSH, Pittsburgh, PA.
- Karacan, C.Ö., Goodman, G., 2009. Hydraulic conductivity changes and influencing factors in longwall overburden determined by slug tests in gob gas ventholes. *International Journal of Rock Mechanics and Mining Sciences* 46, 1162–1174.
- Karacan, C.Ö., Goodman, G., 2011a. Probabilistic modeling using bivariate normal distributions for identification of flow and displacement intervals in longwall overburden. *International Journal of Rock Mechanics and Mining Sciences* 48, 27–41.
- Karacan, C.Ö., Goodman, G., 2011b. Monte Carlo simulation and well testing applied in evaluating reservoir properties in a deforming longwall overburden. *Transport in Porous Media* 86, 445–464.
- Karacan, C.Ö., Goodman, G., submitted for publication. A CART technique to adjust production from longwall coal operations under ventilation constraints. *SME Mining Engineering Journal*.
- Karacan, C.Ö., Luxbacher, K., 2010. Stochastic modeling of gob gas venthole production performances in active and completed longwall panels of coal mines. *International Journal of Coal Geology* 84, 125–140.
- Karacan, C.Ö., Mitchell, G.D., 2003. Behavior and effect of different coal microlithotypes during gas transport for carbon dioxide sequestration into coal seams. *International Journal of Coal Geology* 53, 201–217.
- Karacan, C.Ö., Okandan, E., 2001. Adsorption and gas transport in coal microstructure: investigation and evaluation by quantitative X-ray CT imaging. *Fuel* 80, 509–520.
- Karacan, C.Ö., Diamond, W.P., Schatzel, S.J., 2007a. Numerical analysis of the influence of in-seam horizontal methane drainage boreholes on longwall face emission rates. *International Journal of Coal Geology* 72, 15–32.
- Karacan, C.Ö., Esterhuizen, G.S., Schatzel, S., Diamond, W.P., 2007b. Reservoir-simulation based modeling for characterizing longwall methane emissions and gob gas venthole production. *International Journal of Coal Geology* 71, 225–245.
- Karacan, C.Ö., Ulery, J., Goodman, G.V.R., 2008. A numerical evaluation on the effects of impermeable faults on degasification efficiency and methane emissions during underground coal mining. *International Journal of Coal Geology* 75, 195–203.
- Keojevic, V., Willis, D., Wilkinson, W., Schissler, A., 2005. Computer mapping of faults in coal mining. *International Journal of Coal Geology* 64, 79–84.
- Kedzior, S., 2009. Accumulation of coal-bed methane in the south-west part of the Upper Silesian Coal Basin (southern Poland). *International Journal of Coal Geology* 80, 20–34.
- Kim, A.G., 1977. Estimating methane content of the bituminous coal beds from adsorption data. US Bureau of Mines Report of Investigations No. 8245. US Bureau of Mines, Pittsburgh, PA.
- Kirchgesner, A.D., Piccot, S.D., Winkler, J.D., 1993. Estimate of global methane emissions from coal mines. *Chemosphere* 26, 453–472.
- Kirchgesner, A.D., Masemore, S.S., Piccot, S.D., 2002. Engineering and economic evaluation of gas recovery and utilization technologies at selected US mines. *Environmental Science and Policy* 5, 397–409.
- Kissell, F.N., McCulloch, C.M., Elder, C.H., 1973. The direct method of determining methane content of coal beds for ventilation design. Report of Investigations, 7767. US Bureau of Mines, Pittsburgh, PA.
- Lamarre, R.A., 2003. Hydrodynamic and stratigraphic controls for a large coalbed methane accumulation in Ferron coals of east-central Utah. *International Journal of Coal Geology* 56, 97–110.
- Lamberson, M.N., Bustin, R.M., 1993. Coalbed methane characteristics of Gates Formation coals. *AAPG Bulletin* 77, 2062–2076.
- Lambert, D.C., McDonough, K.M., Dzombak, D.A., 2004. Long-term changes in quality of discharge water from abandoned underground coal mines in Uniontown Syncline, Fayette County, PA, USA. *Water Research* 38, 277–288.
- Laubach, S.E., Marrett, R., Olson, J., Scott, A.R., 1998. Characteristics and origins of coal cleat: a review. *International Journal of Coal Geology* 35, 175–207.
- Laxminarayana, C., Crosdale, P.J., 1999. Role of coal type and rank on methane sorption characteristics of Bowen Basin, Australia coals. *International Journal of Coal Geology* 40, 309–325.
- Li, H., 2001. Major and minor structural features of a bedding shear zone along a coal seam and related gas outburst, Pingdingshan coalfield, Northern China. *International Journal of Coal Geology* 47, 101–113.
- Li, H., Ogawa, Y., Shimida, S., 2003. Mechanism of methane flow through sheared coals and its role on methane recovery. *Fuel* 82, 1271–1279.
- Lu, T., Yu, H., Zhou, T., Mao, J., Guo, B., 2009. Improvement of methane drainage in high gassy coal seam using waterjet technique. *International Journal of Coal Geology* 79, 40–48.
- Lunarzewski, L.W., 1998. Gas emission prediction and recovery in underground coal mines. *International Journal of Coal Geology* 35, 117–145.
- M2M, 2010. Methane to Markets Partnership Project Database. <http://www.methanetomarkets.org/projects/index.aspx?sector=coal>.
- Manchioni, D., 2003. Coal gas contents in Western Canada Basin (and some comments on measurement). 2nd Annual Coalbed Methane Symposium, Calgary, Alberta.
- Mastalerz, M., Gluskoter, H., Rupp, J., 2004. Carbon dioxide and methane adsorption in high volatile bituminous coals from Indiana. *International Journal of Coal Geology* 60, 43–57.
- McCulloch, C.M., Diamond, W.P., Bench, B.M., Deul, M., 1975. Selected geologic factors affecting mining of the Pittsburgh Coalbed. Report of Investigations No. 8093. US Dept. of Interior, US Bureau of Mines, Pittsburgh, PA.
- Michael Mitariten, P.E., 2009. Guild Associates, Inc. Molecular Gate® adsorption system for the removal of carbon dioxide and/or nitrogen from coalbed and coal mine methane. Western States Coal Mine Methane Recovery and Use Workshop, 19–20 April, Two Rivers Convention Center Grand Junction, CO.
- Molinda, G.M., Ingram, D.K., 1989. Effects of structural faults on ground control in selected coal mines in Southwestern Virginia. Report of Investigations No. 9289. US Dept. of Interior, US Bureau of Mines, Pittsburgh, PA.
- Moore, P., 1989. The ecology of peat-forming processes: a review. *International Journal of Coal Geology* 12, 89–103.
- Noack, K., 1998. Control of gas emissions in underground coal mines. *International Journal of Coal Geology* 35, 57–82.
- Palchik, V., 2003. Formation of fractured zones in overburden due to longwall mining. *Environmental Geology* 44, 28–38.
- Palmer, I., 2008. Coalbed methane wells are cheap, but permeability can be expensive! *Energy Tribune*. 10–13. March.
- Palmer, I., 2010. Coalbed methane completions: a world view. *International Journal of Coal Geology* 82, 184–195.
- Palmer, I., Cameron, J., 2003. Coalbed methane completions: update on recent practices. *Procs. Coalbed Methane Symposium*. Canadian Institute, Calgary, Canada. April.
- Pashin, J.C., 1998. Stratigraphy and structure of coalbed methane reservoirs in the United States: an overview. *International Journal of Coal Geology* 35, 209–240.
- Pashin, J.C., Groshong, R.H., 1998. Structural control of coalbed methane production in Alabama. *International Journal of Coal Geology* 38, 89–113.
- Peng, S.S., 2006. *Longwall Mining*, Second edition. Morgantown, WV. 621 pp.
- Qu, P., Shen, R., Fu, Li, Wang, Z., 2010. Time delay effect due to pore pressure changes and existence of cleats on borehole stability in coal seam. *International Journal of Coal Geology*. doi:10.1016/j.coal.2010.10.013.
- Saghafi, A., Williams, D.J., Lama, R.D., 1997. Worldwide methane emissions from underground coal mining. In: Ramani, R.V. (Ed.), *Proceedings of the 6th International Mine Ventilation Congress*. May, Pittsburgh, PA, pp. 17–22.
- Shepherd, J., Rixon, L.K., Griffiths, L., 1981. Outbursts and geological structures in coal mines: a review. *Int. J. Rock Mech. Min. Sci. and Geotechn. Abstr.* 18, 267–283.
- Silva, M.B., Kalkkeith, W., Holz, M., 2008. Coal petrology of coal seams from the Leão-Butia Coalfield, Lower Permian of the Parana Basin, Brazil—implications for coal facies interpretations. *International Journal of Coal Geology* 73, 331–358.
- Somers, J.M., Shultz, H.L. 2008. Thermal oxidation of coal mine ventilation air methane. 12th U.S./North American Mine Ventilation Symposium, 2008—Wallace (ed) ISBN 978-0-615-20009-5.
- Spafford, S., 2007. Recent Production from Laterals in Coal Seams: SPE ATW on Coalbed Methane. Durango, Colorado. March 27–29.
- Sparks, D.P., Lambert, S.W., McLendon, T.H., 1993. Coalbed gas well flow performance controls, Cedar Cove Area, Warrior Basin, USA. Proc. 1993. *International Coaled Methane Symposium*, Tuscaloosa, AL, pp. 529–548.
- Steidl, P., 1996. Chapter 2: coal as a reservoir. In: Saulsberry, J.L., Scahfer, P.S., Schraufnagel, R.A. (Eds.), *Coalbed Methane Reservoir Engineering*. Gas Research Institute, Chicago, IL.
- Su, X., Zhang, L., Zhang, R., 2003. The abnormal pressure regime of the Pennsylvanian No. 8 coalbed methane reservoir in Liulin-Wupu District, Eastern Ordos Basin, China. *International Journal of Coal Geology* 53, 227–239.

- Su, S., Beath, A., Guo, H., Mallett, C., 2005. An assessment of mine methane mitigation and utilisation technologies. *Progress in Energy and Combustion Science* 31, 123–170.
- Su, X., Lin, X., Liu, S., Zhao, M., Song, Y., 2005. Geology of coalbed methane reservoirs in the Southeast Qinshui Basin of China. *International Journal of Coal Geology* 62, 197–210.
- Su, S., Chen, H., Teakle, P., Xue, S., 2008. Characteristics of coal mine ventilation air flows. *Journal of Environmental Management* 86, 44–62.
- Thakur, P.C., 2006. Coal seam degasification. In: Kissell, F. (Ed.), *Handbook for Methane Control in Mining*. Information Circular No: 9486. NIOSH, Pittsburgh, PA.
- Thakur, P.C., Poundstone, W.N., 1980. Horizontal drilling technology for advance degasification. *Mining Engineering* 676–680 June.
- Thielemann, T., Lücke, A., Schleser, G.H., Littke, R., 2000. Methane exchange between coal-bearing basins and the atmosphere: the Ruhr Basin and the Lower Rhine Embayment, Germany. *Organic Geochemistry* 31, 1387–1408.
- Thielemann, T., Kroos, B.M., Littke, R., Welte, D.H., 2001. Does coal mining induce methane emissions through the lithosphere/atmosphere boundary in the Ruhr Basin, Germany. *Journal of Geochemical Exploration* 74, 219–231.
- U.S. EIA, 2008. *International Energy Statistics 2008*. U.S. Energy Information Administration, Washington, DC.
- U.S. EIA, 2009a. *International Energy Statistics 2009*. U.S. Energy Information Administration, Washington, DC.
- U.S. EIA, 2009b. *Annual Energy Review 2009*. U.S. Energy Information Administration, Washington, DC.
- U.S. EPA, 1999. Conceptual design for a coal mine gob well flare. U.S. Environmental Protection Agency, Air and Radiation 430-R-99-012.
- U.S. EPA, 2000. Benefits of an enclosed gob well flare design for underground coal mines, addendum to: conceptual design for a coal mine gob well flare (EPA 430-R-99-012). U.S. Environmental Protection Agency, Air and Radiation.
- U.S. EPA, 2003. Assessment of the worldwide market potential for oxidizing coal mine ventilation air methane. United States Environmental Protection Agency. EPA 430-R-03-002.
- U.S. EPA, 2004. Methane emissions from abandoned coal mines in the United States: emissions inventory methodology and 1990–2002 emissions estimates. United States Environmental Protection Agency. EPA 430-R-04-001.
- U.S. EPA, 2006. Global anthropogenic non-CO₂ greenhouse gas emissions: 1990–2020. U.S. Environmental Protection Agency.
- U.S. EPA, 2008. Upgrading drained coal mine methane to pipeline quality: a report on the commercial status of system suppliers. US Environmental Protection Services, Coalbed Methane Outreach Program. EPA-430-R08-004.
- U.S. EPA, 2009a. Global overview of CMM opportunities. US Environmental Protection Agency Coalbed Methane Outreach Program In support of the Methane to Markets Partnership.
- U.S. EPA, 2009b. US EPA 2009 Coal Mining Inventory.
- U.S. EPA, 2009c. US EPA 2009 Abandoned Underground Coal Mines Inventory.
- U.S. EPA, 2009d. Coal Mine Methane Recovery: A Primer U.S. Environmental Protection Agency. EPA 430-R-09-013.
- U.S. EPA, 2009e. Identifying Opportunities for Methane Recovery at U.S. Coal Mines: Profiles of Selected Gassy Underground Coal Mines 2002–2006. U.S. Environmental Protection Agency. EPA 430-K-04-003.
- U.S. EPA, 2009f. Ventilation air methane (VAM) utilization technologies. U.S. Environmental Protection Agency Coalbed Methane Outreach Program. www.epa.gov/cmop.
- U.S. EPA, 2010a. Inventory of U.S. Greenhouse Gas Emissions and Sinks:1990–2008. U.S. Environmental Protection Agency. EPA 430-R-10-006.
- U.S. EPA, 2010b. U.S. Greenhouse Gas Inventory Report. United States Environmental Protection Agency. EPA 430-R-10-006.
- Ulery, J., 2006. Managing excess gas emissions associated with coal mine geologic features. In: Kissell, F. (Ed.), *Handbook for Methane Control in Mining*. NIOSH, Pittsburgh, PA. Information Circular No: 9486.
- United Nations, 2010. Best practice guidance for effective methane drainage and use in coal mines. Economic Commission for Europe Methane to Markets Partnership: ECE Energy Series, 31.
- Warmuzinski, K., 2008. Harnessing methane emissions from coal mining. *Process Safety and Environment Protection* 86, 315–320.
- Whittles, D.N., Lowndes, I.S., Kingman, S.W., Yates, C., Jobling, S., 2006. Influence of geotechnical factors on gas flow experienced in a UK longwall coal mine panel. *International Journal of Rock Mechanics & Mining Sciences* 43, 369–387.
- Whittles, D.N., Lowndes, I.S., Kingman, S.W., Yates, C., Jobling, S., 2007. The stability of methane capture boreholes around a long wall coal panel. *International Journal of Coal Geology* 71, 313–328.
- Yao, Y., Liu, D., Tang, D., Tang, S., Che, Y., Huang, W., 2009. Preliminary evaluation of the coalbed methane production potential and its geological controls in the Weibei Coalfield, Southeastern Ordos Basin, China. *International Journal of Coal Geology* 78, 1–15.
- Zhang, L., Cao, P., Radha, K.C., 2010. Evaluation of rock strength criteria for wellbore stability analysis. *International Journal of Rock Mechanics and Mining Sciences* 47 (8), 1304–1316.
- Zhao, C., Hebblewhite, B.K., Galvin, J.M., 2000. Analytical solutions for mining induced horizontal stress in floors of coal mining panels. *Comput. Methods Appl. Mech. Engrg.* 184, 125–142.